

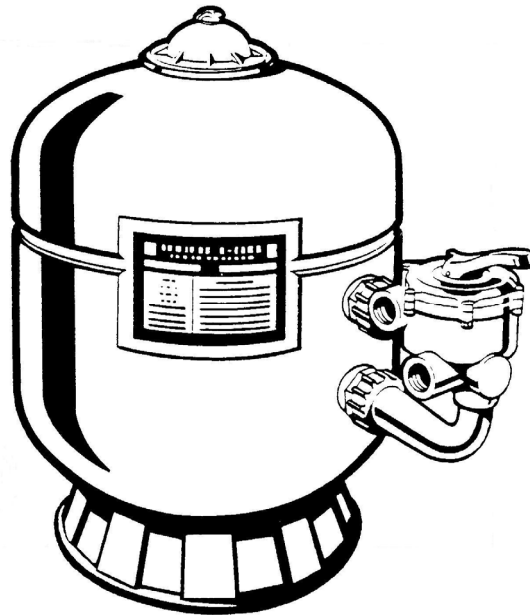

# HAYWARD®

## OWNER'S MANUAL INSTALLATION, OPERATION & PARTS



### MODELS S210S, S244S PRO™ SERIES HIGH RATE SAND FILTERS

Basic safety precautions should always be followed, including the following: Failure to follow instructions can cause severe injury and/or death.

 This is the safety-alert symbol. When you see this symbol on your equipment or in this manual, look for one of the following signal words and be alert to the potential for personal injury.

 **WARNING** warns about hazards that **could** cause serious personal injury, death or major property damage and if ignored presents a potential hazard.

 **CAUTION** warns about hazards that **will** or **can** cause minor or moderate personal injury and/or property damage and if ignored presents a potential hazard. It can also make consumers aware of actions that are unpredictable and unsafe.

The **NOTICE** label indicates special instructions that are important but not related to hazards.

### SAVE THIS INSTRUCTION MANUAL

Use only High Rate Sand No. 20 Silica Sand (.45mm - .55mm)



## HAYWARD POOL PRODUCTS, INC.

620 Division Street Elizabeth, NJ 07207 Tel: 908-351-5400  
WWW.HAYWARDPOOL.COM



**⚠ - WARNING - Read and follow all instructions in this owner's manual and on the equipment. Failure to follow instructions can cause severe injury and/or death.**



**⚠ WARNING – Suction Entrapment Hazard.**

Suction in suction outlets and/or suction outlet covers which are, damaged, broken, cracked, missing, or unsecured can cause severe injury and/or death due to the following entrapment hazards:

**Hair Entrapment-** Hair can become entangled in suction outlet cover.

**Limb Entrapment-** A limb inserted into an opening of a suction outlet sump or suction outlet cover that is damaged, broken, cracked, missing, or not securely attached can result in a mechanical bind or swelling of the limb.

**Body Suction Entrapment-** A negative pressure applied to a large portion of the body or limbs can result in an entrapment.

**Evisceration/ Disembowelment -** A negative pressure applied directly to the intestines through an unprotected suction outlet sump or suction outlet cover which is, damaged, broken, cracked, missing, or unsecured can result in evisceration/ disembowelment.

**Mechanical Entrapment-** There is potential for jewelry, swimsuit, hair decorations, finger, toe or knuckle to be caught in an opening of a suction outlet cover resulting in mechanical entrapment.

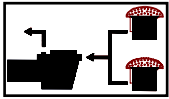

**⚠ WARNING - To Reduce the risk of Entrapment Hazards:**

- o When outlets are small enough to be blocked by a person, a minimum of two functioning suction outlets per pump must be installed. Suction outlets in the same plane (i.e. floor or wall), must be installed a minimum of three feet (3') [1 meter] apart, as measured from near point to near point.
- o Dual suction fittings shall be placed in such locations and distances to avoid “dual blockage” by a user.
- o Dual suction fittings shall not be located on seating areas or on the backrest for such seating areas.
- o The maximum system flow rate shall not exceed the flow rating of as listed on Table 2.
- o Never use Pool or Spa if any suction outlet component is damaged, broken, cracked, missing, or not securely attached.
- o Replace damaged, broken, cracked, missing, or not securely attached suction outlet components immediately.
- o In addition two or more suction outlets per pump installed in accordance with latest NSPI, IAF Standards and CPSC guidelines, follow all National, State, and Local codes applicable.
- o Installation of a vacuum release or vent system, which relieves entrapping suction, is recommended.

**⚠ WARNING – Failure to remove pressure test plugs and/or plugs used in winterization of the pool/spa from the suction outlets can result in an increase potential for suction entrapment as described above.**

**⚠ WARNING – Failure to keep suction outlet components clear of debris, such as leaves, dirt, hair, paper and other material can result in an increase potential for suction entrapment as described above.**

**⚠ WARNING – Suction outlet components have a finite life, the cover/grate should be inspected frequently and replaced at least every ten years or if found to be damaged, broken, cracked, missing, or not securely attached.**

**⚠ CAUTION – Components such as the filtration system, pumps and heater must be positioned so as to prevent their being used as means of access to the pool by young children.**

**⚠ WARNING – Never operate or test the circulation system at more than 40 PSI.**

**⚠ CAUTION – All electrical wiring MUST be performed by a qualified professional, and MUST conform to local codes and regulations.**

**⚠ WARNING – Never change the filter control valve position while the pump is running.**



**⚠ WARNING – Hazardous Pressure.** Pool and spa water circulation systems operate under hazardous pressure during start up, normal operation, and after pump shut off. Stand clear of circulation system equipment during pump start up. Failure to follow safety and operation instructions could result in violent separation of the pump housing and cover, and/or filter housing and clamp due to pressure in the system, which could cause property damage, severe personal injury, or death. Before servicing pool and spa water circulation system, all system and pump controls must be in off position and filter manual air relief valve must be in open position. Before starting system pump, all system valves must be set in a position to allow system water to return back to the pool. Do not change filter control valve position while system pump is running. Before starting system pump, fully open filter manual air relief valve. Do not close filter manual air relief valve until a steady stream of water (not air or air and water) is discharged.



**⚠ WARNING – Separation Hazard.** Failure to follow safety and operation instructions could result in violent separation of pump and/or filter components. Strainer cover must be properly secured to pump housing with strainer cover lock ring. Before servicing pool and spa circulation system, the filter's manual air relief valve must be in open position. Do not operate pool and spa circulation system if a system component is not assembled properly, damaged, or missing. Do not operate pool and spa circulation system unless filter manual air relief valve body is in locked position in filter upper body.



**WARNING** – **Electrical** Ground motor before connecting to electrical power supply. Failure to ground pump motor can cause serious or fatal electrical shock hazard.

**WARNING** – Do NOT ground to a gas supply line.

**WARNING** – To avoid dangerous or fatal electrical shock, turn OFF power to motor before working on electrical connections.

**WARNING** – Failure to bond pump to pool structure will increase risk for electrocution and could result in injury or death. To reduce the risk of electric shock, see installation instructions and consult a professional electrician on how to bond pump. Also, contact a licensed electrician for information on local electrical codes for bonding requirements.

Your Hayward Pro Series high-rate sand filter is a high performance, totally corrosion-proof filter that blends superior flow characteristics and features with ease of operation. It represents the very latest in high-rate sand filter technology. It is virtually foolproof in design and operation and when installed, operated and maintained according to instructions, your filter will produce clear, sparkling water with only the least attention and care.

### HOW IT WORKS

Your filter uses special filter sand to remove dirt particles from the water. Filter sand is loaded into the filter tank and functions as the permanent dirt removing media. The pool water, which contains suspended dirt particles, is pumped through your piping system and is automatically directed by the patented filter control valve to the top of the filter tank. As the pool water is pumped through the filter sand, dirt particles are trapped by the sand bed, and filtered out. The cleaned pool water is returned from the bottom of the filter tank, through the control valve and back to the pool through the piping system. This entire sequence is continuous and automatic and provides for total recirculation of pool water through your filter and piping system.

After a period of time, the accumulated dirt in the filter causes a resistance to flow, and the flow diminishes. This means it is time to clean (backwash) your filter. With the control valve in the backwash position, the water flow is automatically reversed through the filter so that it is directed to the bottom of the tank, up through the sand, flushing the previously trapped dirt and debris out the waste line. Once the filter is backwashed (cleaned) of dirt, the control valve is manually resequenced to Rinse, and then Filter, to resume normal filtering.

### INSTALLATION

Only simple tools (screwdriver and wrenches), plus Teflon tape manufactured for plastic adapters, are required to install and/or service the filter.

1. The filter system should be installed, not more than 6 feet above pool water level, on a *level* concrete slab, very firm ground, or equivalent, as recommended by your pool dealer. Position the filter so that the piping connections, control valve and winter drain are convenient and accessible for operation, service and winterizing. Assemble Vari-Flo filter control valve to filter. Align the two (2) valve pipe connections, with O-rings in place, with the two

openings in the side of the filter tank and press in firmly. Secure the assembly to the tank connections with the two bulkhead locknuts.

**Do not overtighten.**

3. Assemble pump and pump mounting base (if supplied) to the filter according to instructions packed with the base.
  4. Loading sand media. Filter sand media is loaded through the top opening of the filter.
    - a. Remove the top diffuser from the internal diffuser elbow pipe and place flexible, automatic air relief tube to the side, out of the way, inside the tank.
    - b. Cap the internal diffuser elbow pipe with the sand shield provided to prevent sand from entering it.
    - c. It is good practice to fill tank approximately 1/2 way with water to provide a cushioning effect when the filter sand is poured in. This helps protect the under-drain laterals from excessive shock. (Be sure the drain cap is securely in place on drain pipe.)
- Note: Check to confirm all laterals are in the down position before loading with sand. (See Figure A on Page 5.)**
- d. Carefully pour in correct amount and grade of filter sand, as specified. Sand surface should be leveled and should come to about 6 " from the top of the filter tank. Use no more than the recommended amount of sand.
  - e. Remove the sand shield from internal diffuser elbow pipe.
  - f. Replace diffuser on internal diffuser elbow pipe, positioning automatic air relief tube through the hole provided in the diffuser.

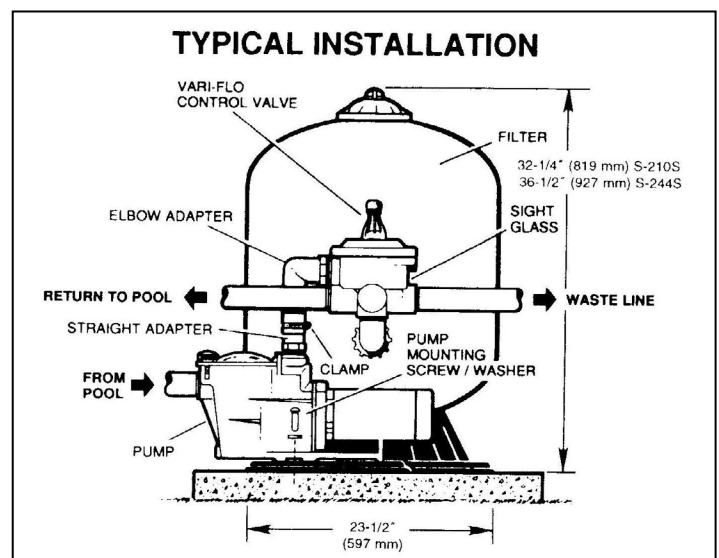

- g. Wipe filter flange clean.
- h. Insert top closure dome (with flange O-ring in place) into the tank neck. Place clamp around dome flange and tank flange and tighten with screwdriver, tapping around clamp with screwdriver handle to help seat flange clamp.

**Do not overtighten.**

5. Connect pump to control valve opening marked PUMP according to instructions. Make return to pool pipe connection to control valve opening marked RETURN and complete other necessary plumbing connections, suction lines to pump, waste, etc.
6. Make electrical connections to pump per pump instructions.
7. To prevent water leakage, be sure drain cap is securely in place and all pipe connections are tight.

#### INITIAL START-UP OF FILTER

1. Be sure correct amount of filter sand media is in tank and that all connections have been made and are secure. **IMPORTANT: To prevent unnecessary strain on piping system and valving, always shut off pump before switching Filter Control Valve positions.**
2. Depress Vari-Flo control valve handle and rotate to BACKWASH\* position. (To prevent damage to control valve seat, always depress handle before turning.)
3. Prime and start pump according to pump instructions. (be sure all suction and return lines are open), allowing the filter tank to fill with water.



**! WARNING** – All suction and discharge valves must be open when starting the system. Failure to do so could cause severe personal injury and/or property damage.

4. Once water flow is steady out the waste line, run the pump for at least 2 minutes. This initial backwashing of the filter is recommended to remove any impurities or fine sand particles in the sand media.
5. Turn pump off and set valve to RINSE position. Start pump and operate until water in sight glass is clear—about 1/2 to 1 minute. Turn pump off, set valve to FILTER position and restart pump. Your filter is now operating in the normal filter mode, filtering particles from the pool water.
6. Adjust pool suction and return valves to achieve desired flow. Check system and filter for water leaks and tighten connections, bolts, nuts, as required.
7. Note the initial pressure gauge reading when the filter is clean. (It will vary from pool to pool depending upon the pump and general piping system.) As the filter removes dirt and impurities from the pool water, the accumulation in the filter will cause the pressure to rise and flow to diminish. When the pressure gauge reading is 6-8 PSI (0.41-0.55 BAR) higher than the initial "clean" pressure you noted, it is time to backwash (clean) the filter (see BACKWASH under Filter Control Valve Functions).

**NOTE: During initial clean-up of the pool water it may be necessary to backwash frequently due to the unusually heavy initial dirt load in the water.**

To prevent damage to the pump and filter and for proper operation of the system, clean pump strainer and skimmer baskets regularly.

#### FILTER CONTROL VALVE FUNCTIONS

**FILTER**—Set valve to FILTER for normal filtering. Also use for regular vacuuming.

**BACKWASH**—For cleaning filter. When filter pressure gauge rises 6-8 PSI (0.41-0.55 BAR) above start-up (clean pressure): Stop the pump, set valve to BACKWASH. Start pump and backwash approximately 2 minutes or less depending on dirt accumulation until water in sight glass is clear. Proceed to RINSE.

**RINSE**—After backwashing, with pump off, set valve to RINSE. Start pump and operate for about 1/2 to 1 minute. This ensures that all dirty water from backwashing is rinsed out to the filter to waste, preventing possible return to the pool. Stop pump, set valve to FILTER, and start pump for normal filtering.

**WASTE**—To bypass filter for draining or lowering water level and for vacuuming heavy debris directly to waste.

**RECIRCULATE**—Water is recirculated through the pool system, bypassing the filter.

**CLOSED**—Shuts off flow from pump to filter.

**VACUUMING**—Vacuuming can be performed directly into the filter. When vacuuming heavy debris loads, set valve to WASTE position to bypass the filter and vacuum directly out to waste.

#### WINTERIZING

1. Completely drain tank by unscrewing drain cap at base of filter tank. Leave cap off during winter.
2. Depress Vari-Flo control valve handle and rotate so as to set pointer on valve top between any two positions. This will allow water to drain from the valve. Leave valve in this "inactive" position.
3. Drain and winterize pump according to pump instructions.

#### SERVICE & REPAIRS

Consult your local authorized *Hayward* dealer or service center. No returns may be made directly to the factory without the expressed authorization of Hayward Pool Products, Inc.

#### PLEASE REALIZE:

Pure, clear swimming pool water is a combination of two factors—adequate filtration and proper water chemistry balance. One without the other will not give the clean water you desire.

Your filter system is designed for continuous operation. However, this is not necessary for most swimming pools. You can determine your filter operation schedule based on your pool size and usage. Be sure to operate your filtration system long enough each day to obtain at least one complete turnover of your pool water.

To properly sanitize your pool, maintain a free chlorine level of 1 to 3 ppm and a pH range of 7.2 to 7.6. Insufficient chlorine or an out of balance pH level will permit algae and bacteria to grow in your pool and make it difficult for your filter to properly clean the pool water.

\*NOTE: For new concrete or gunite pools, or where there is a large amount of plaster dust or debris—start filter in FILTER position (not BACKWASH) to prevent clogging of underdrain laterals.

**SPECIFICATIONS**

MODEL NUMBER	EFFECTIVE FILTRATION AREA		MAXIMUM WORKING PRESSURE		REQUIRED CLEARANCE				MEDIA REQUIRED		
	FT <sup>2</sup>	M <sup>2</sup>	PSI	BAR	SIDE		ABOVE		TYPE	AMOUNT	
					INCH	MM	INCH	MM		FILTER SAND**	LBS
S210S	2.2	.20	50	3.45	18	460	18	460	0.45-0.55mm	200	90
S244S	3.1	.29	50	3.45	18	460	18	460	0.45-0.55mm	300	135

\*\*Also known as No. 20 Silica Sand.

TABLE 1

**PARTS**  
**Models S210S, S244S**

REF NO	PART NO.	DESCRIPTION	NO. REQ
1	SX200G	Manual Air Relief Cap	1
2	SX200Z5	O-RING, 13/16" O.D.	1
3	SX244K	Top Closure Dome	1
4	GMX600F	Valve/tank o-ring	1
5	GMX600NM	Flange Clamp	1
6a	SX210AA2FW	Filter Tank w/Base, S210S	1
6b	SX244AA2FW	Filter Tank w/Base, S244S	1
7	SX244G	Top Diffuser	1
8a	SX210CD1FW	Top Elbow Assembly (S210S)	1
8b	SX244CD1FW	Top Elbow Assembly (S244S)	1
9a	SX210CD2FW	Bottom Elbow Assembly (S210S)	1
9b	SX244CD2FW	Bottom Elbow Assembly (S244S)	1
10a	SX200Q	Lateral (Screw in) Prior 2005(20")	10
10b	SX200DN	Lateral (One piece) (20")	10
10c	SX240D	Lateral (Screw in) Prior to 2005	10
10d	SX240DN	Lateral (One piece)	10
11a	SX242MAX	Lateral Holder Assy w/S200DN	1
11b	SX242MA1X	Lateral Holder Assy w/S240DN	1
12a	CX3000Z2	Plastic Air Tube (S210S)	1
12b	CX1100Z4	Plastic Air Tube (S244S)	1
13	SX200Z2	Air Tube Lock Screw	1
14a	SX108HG	Drain Cap Kit (Round)	1
14b	SX180LA	Drain Cap Assy	1
15	SX202S	Sand shield, corrugated	1
16	SX200J	Filter Stand Support	1
17a	SX220Z3	O-Ring (Large) (S210S)	2
17b	SX360Z1	O-Ring (S244S)	4
18a	DEX360F	Bulkhead Fitting (S210S)	2
18b	SX244P	Bulkhead Fitting (S244S)	2
19	SP710X62	1 1/2" Vari-Flo Control Valve Assembly with Gauge	1
20	SX200Z4	O-Ring	2
21	ECX27061	Pressure Gauge	1
22	SX360E	O-Ring Spacer (S244S)	2

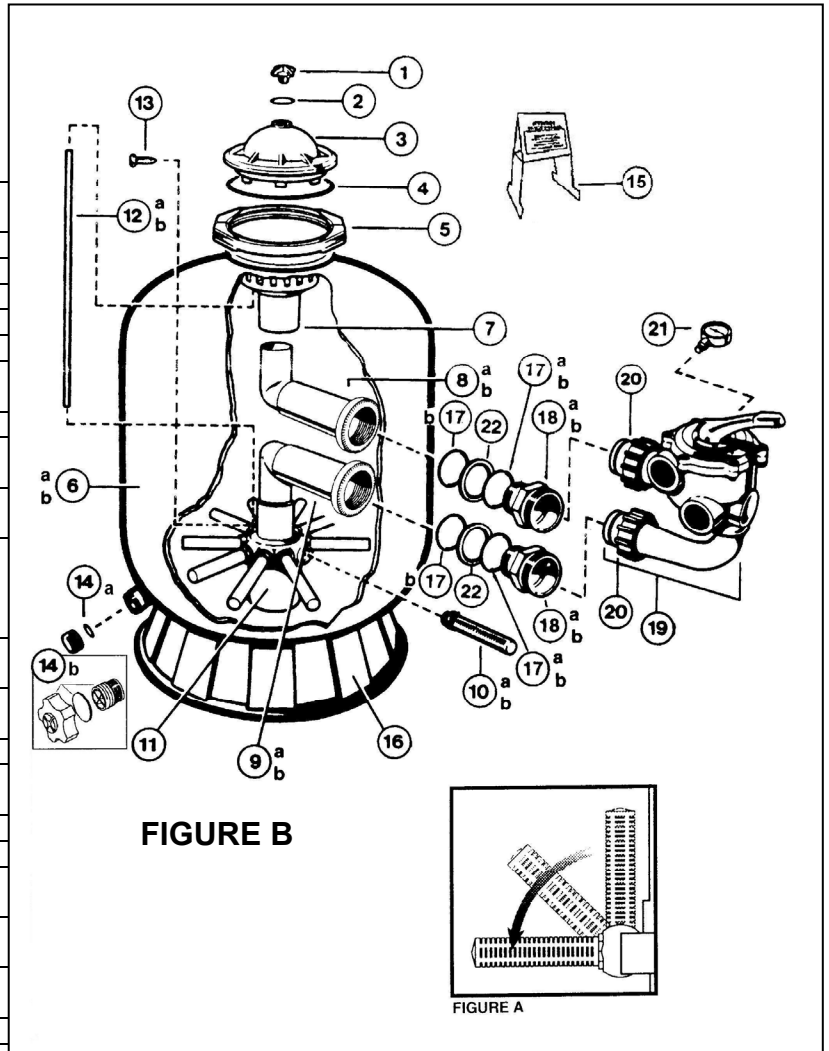



MAXIMUM RECOMMENDED SYSTEM FLOW RATE BY PIPE SIZE					
Pipe Size	Flow rate	Pipe Size	Flow rate	Pipe Size	Flow rate
[mm]	GPM [Liter/Min]	[mm]	GPM [Liter/Min]	[mm]	GPM [Liter/Min]
1"	20	1 1/2"	45	2 1/2"	110
[32]	[75]	[50]	[170]	[75]	[415]
1 1/4"	30	2"	80	3"	160
[40]	[110]	[63]	[300]	[90]	[600]

**TABLE 2**

<b>PRODUCT REGISTRATION</b>	
(Retain For Your Records)	
DATE OF INSTALLATION _____	
PURCHASED FROM _____	
MODEL _____	SERIAL NUMBER _____
▲ Retain this Warranty Certificate in a safe and convenient location for your records.	

**PROBLEM SOLVING LIST**

	LOW WATER FLOW	SHORT FILTER CYCLES	POOL WATER WON'T CLEAR UP
<b>REMEDY</b>	1. Check skimmer and pump strainer baskets for debris. 2. Check for restrictions in intake and discharge lines. 3. Check for air leak in intake line (indicated by bubbles returning to pool). 4. Backwash filter.	1. Check for algae in pool and superchlorinate as required. 2. Be sure chlorine and pH levels are in proper range (adjust as required). 3. Check surface of filter sand for crusting or caking (remove 1 " of sand if necessary).	1. Check chlorine, pH and total alkalinity levels and adjust as required. 2. Be sure flow rate through filter is sufficient. 3. Operate filter for longer periods. 4. Be sure Vari-Flo valve is set on "Filter" position.

**POOL CHEMISTRY GUIDELINES**

SUGGESTED POOL CHEMISTRY LEVELS	ACTION REQUIRED TO CORRECT POOL CHEMISTRY	
	TO RAISE	TO LOWER
pH 7.2 to 7.6	Add Soda Ash	Add Muriatic Acid or Sodium Bisulphate
TOTAL ALKALINITY 100 to 130 ppm	Add Sodium Bicarbonate	Add Muriatic Acid
CHLORINE (UNSTABILIZED) 0.3 to 1.0 ppm	Add Chlorine Chemical	No action - chlorine will naturally dissipate
CHLORINE (STABILIZED) 1.0 to 3.0 ppm	Add Chlorine Chemical	No action - chlorine will naturally dissipate
CHLORINE STABILIZER (Cyanuric Acid) 40 to 70 ppm	Add Stabilizer	Dilution - partially drain & refill pool with water that has not been treated with Cyanuric Acid.

### HAYWARD® LIMITED WARRANTY

This equipment was inspected before shipment from our plant. To original purchasers of this equipment, Hayward Pool Products, Inc., 620 Division Street, Elizabeth, New Jersey, warrants its products free from defects in materials and workmanship for a period of **ONE (1)** year from the date of purchase.

Parts which fail or become defective during the warranty period, except as a result of freezing, negligence, improper installation, use, or care, shall be repaired or replaced, at our option, without charge, within 90 days of the receipt of defective product, barring unforeseen delays.

To obtain warranty replacements or repair, defective components or parts should be returned, transportation paid, to the place of purchase, or to the nearest authorized Hayward service center. For further Hayward dealer or service center information, contact Hayward customer service department. No returns may be made directly to the factory without the express written authorization of Hayward Pool Products, Inc.

To original purchasers of this equipment, Hayward Pool Products, Inc. warrants its vacuum release systems to be free from defects in materials and workmanship for a period of **ONE (1)** year from the date of purchase.

Filters which become defective during the warranty period, except as a result of freezing, negligence, improper installation, use or care, shall be repaired or replaced, at our option, without charge.

All other conditions and terms of the standard warranty apply.

Hayward shall not be responsible for cartage, removal and/or reinstallation labor or any other such costs incurred in obtaining warranty replacements.

The Hayward Pool Products warranty does not apply to components manufactured by others. For such products, the warranty established by the respective manufacturer will apply.

Some states do not allow a limitation on how long an implied warranty lasts, or the exclusion or limitation of incidental or consequential damages, so the above limitation or exclusion may not apply to you.

This warranty gives you specific legal rights, and you may also have other rights, which vary from state to state.

Hayward Pool Products, Inc.  
620 Division Street  
Elizabeth, NJ 07207

\*Supersedes all previous publications.

▼ **DETACH HERE: Fill out bottom portion completely and mail within 10 days of purchase/installation.**

© Hayward Pool Products, Inc. 2006

All rights reserved.



Mail to: Hayward Pool Products, Inc., 620 Division Street, Elizabeth, NJ 07207, Attn: Warranty Dept.

# HAYWARD®

## Warranty Registration Card

Name \_\_\_\_\_

Years pool has been in service  less than 1  1-3  3-5  5-10

Address \_\_\_\_\_

Purchased from: \_\_\_\_\_

City \_\_\_\_\_ State \_\_\_\_\_ Zip \_\_\_\_\_

Company name \_\_\_\_\_

E-mail Address \_\_\_\_\_

Address \_\_\_\_\_

Product Purchased \_\_\_\_\_

City \_\_\_\_\_ State \_\_\_\_\_ Zip \_\_\_\_\_

Product Serial No. \_\_\_\_\_

New Installation  Replacement

**Please send me more information on these other products from Hayward:**

Type of In-Ground Pool:

Vinyl  Fiberglass  Gunite

Pump  Filter  Automatic Pool Cleaner  Light

Chlorinator  Skimmer  Heater  Heat Pump

Salt/Chlorine Generator  Controls

Size of Pool \_\_\_\_\_

[WWW.HAYWARDPOOL.COM](http://WWW.HAYWARDPOOL.COM)

**USE ONLY HAYWARD GENUINE REPLACEMENT PARTS**

**THIS PAGE LEFT BLANK**