

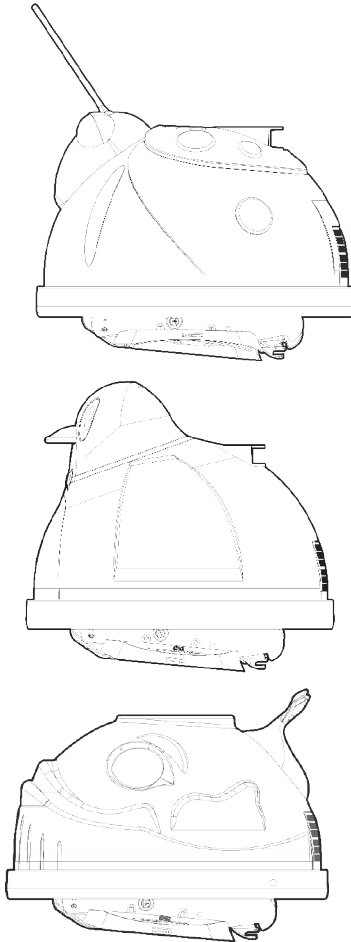

ABOVE GROUND SERIES

Suction Pool Cleaner Owner's Manual



TURBINE SUCTION CLEANER

Owner's Manual

Congratulations on the purchase of your Hayward automatic suction pool cleaning system. Your cleaner is the smart, efficient way to clean your above-ground pool.

Hayward turbine cleaners are powered by your pool's filter system and are designed to work well with most systems. The performance of the cleaner in your pool will be relative to its power source. Because the operation and performance of the cleaner are system reliant, there is a remote possibility that a service call may be necessary to complete the proper installation of your cleaner. This call will be at the consumer's expense.

Lastly, one or more of the accessories designed for the cleaner, including additional hose sections, might be applicable to your installation. Consult your Hayward dealer for prices and availability.

FOR YOUR RECORDS

Purchase Date:

Serial Number:

SAFETY WARNINGS

DO NOT use to remove large debris in new pools.

REMOVE cleaner and hose before adding ANY chemicals to your pool.

DO NOT swim with cleaner.

Store the cleaner in a shaded, safe area.

Hoses must be stored straight. **DO NOT** coil the hose.

KEEP AWAY from children and pets.

REMOVE cleaner when performing backwash.

REMEMBER safety first.

For complete warnings and safety information visit www.hayward.com.

KEY

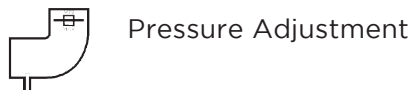



CARTON CONTENTS

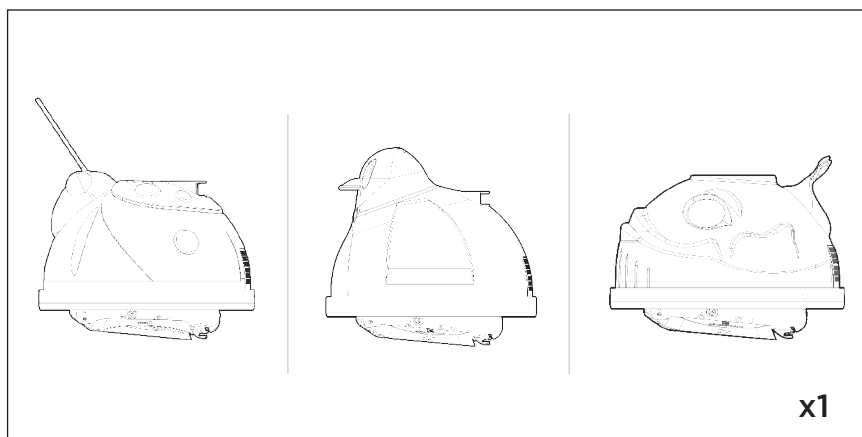

Pool Cleaner

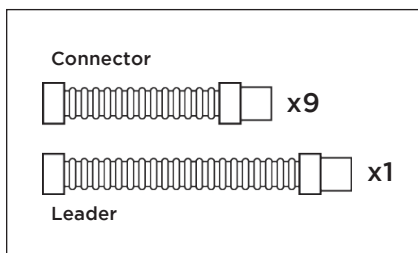

Connector/Leader Hoses

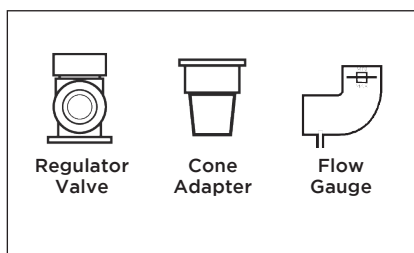

Accessory Kit

PREPARING THE POOL

Please complete the following steps to prepare your pool for installation:

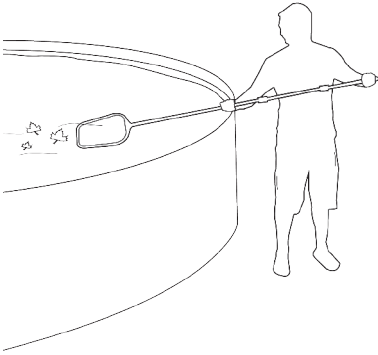

DEBRIS

Remove any large objects and excessive debris from the pool.

WATER LEVEL

Confirm that water level is at the recommended level.

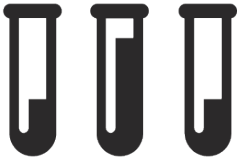

pH: 7.2 - 7.8
Chlorine: 1.0-3.0 PPM
Total Alkalinity: 80 - 120 PPM

WATER CHEMISTRY

Make sure water is properly balanced and that the pool is free from algae.

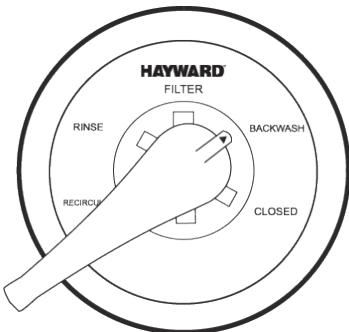

FILTER

Clean or backwash the filter.

Clean the skimmer and pump baskets prior to installing the cleaner.

INSTALLATION

Sizing Suction Hose

Step 1

Connect hose sections.

Note: Make sure all connections are tight to prevent air leaks.

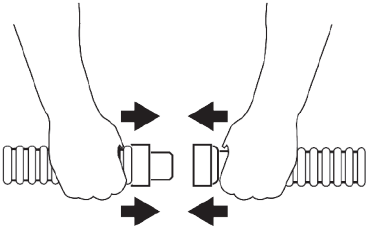

TIP: *Wetting the hose ends will make it easier to connect the hose sections.*



If optional leaf canister is purchased, install between 1st and 2nd hose sections starting from the wall connector or skimmer.

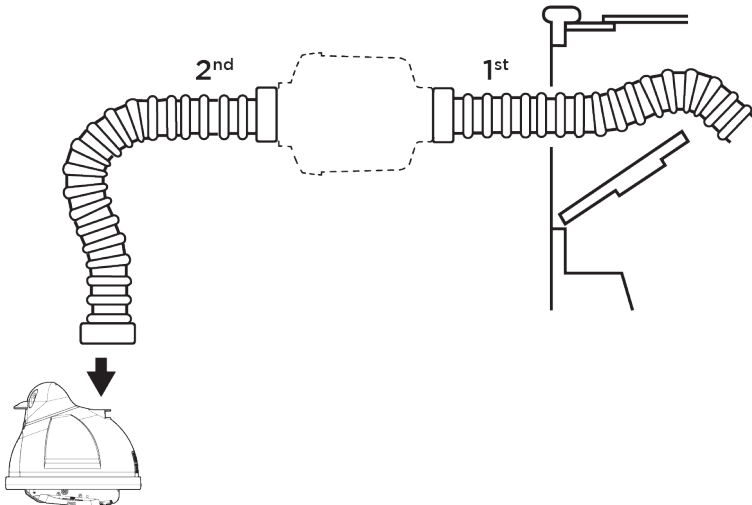

Step 2

Pull hose to farthest location in the pool opposite the wall connector or skimmer **+ 2 extra hose sections**.

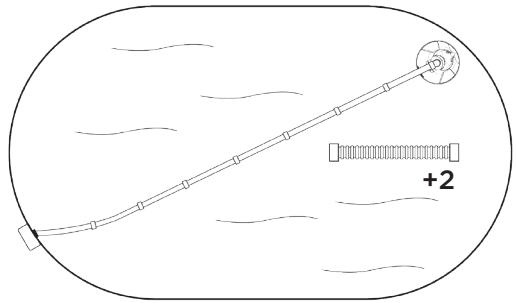
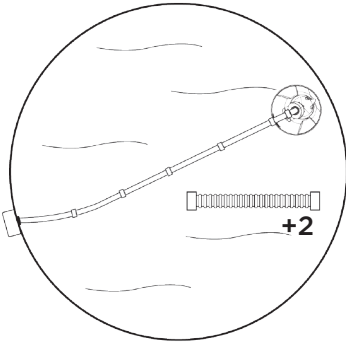

Step 3



Fill hose completely with water.
Insert flow gauge onto the leader hose. Attach the C-clip of the gauge onto the 1st hose section.

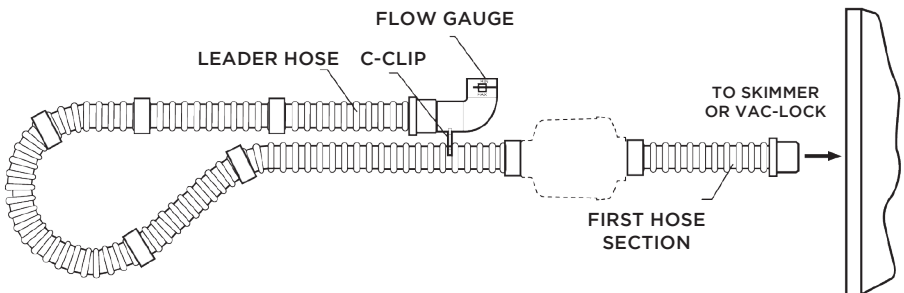

 Make sure the flow gauge is under water.

INSTALLATION

Step 4

Connecting to skimmer:

Connect the skimmer cone adapter to tapered male end of the first hose section.

Note: Hose end goes into cone adapter.

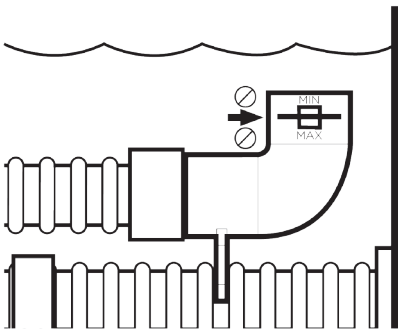
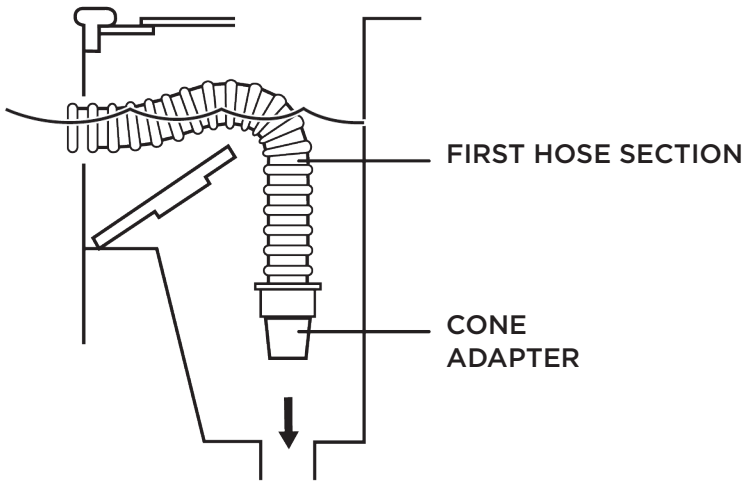

Step 5



Check the water flow reading on the flow gauge.

The black disk should be between the "MIN" and "MAX" markings.

If the disk is in the proper location, move on to step 6.

Reading Too High?

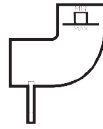

If the black disk is outside of the box on the “MAX” side and you have connected your hose to the skimmer, reduce the vacuum/ water flow by using one of the following:

- Suction valve(s) in the filter system (if equipped with)
- Hayward regulator valve

To install the Hayward regulator valve:



1. Remove the hose from the skimmer cone adapter.
2. Close the regulator valve by rotating the blue collar clockwise until tight.
3. Insert the regulator valve onto the skimmer cone adapter and the hose end into the regulator valve.
4. Turn the filter system on and allow it to evacuate any air in the system.
5. Turn the blue collar clockwise until black disk appears between “MIN” and “MAX” markings.

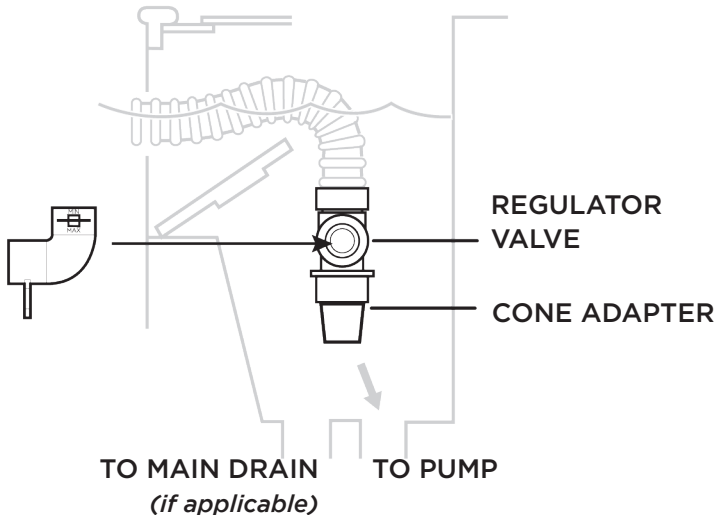

INSTALLATION

Reading Too Low?

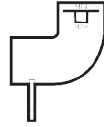

An initial vacuum reading that is TOO low to meet the water flow setting necessary to operate the cleaner is indicative of a system problem, and not a problem with the cleaner.

The regulator valve cannot be used to INCREASE the initial vacuum reading.

View our YouTube video at
www.youtube.com/watch?v=aqyrv_9nJZI
or contact your authorized Hayward Dealer for assistance.

Step 6

Submerge the cleaner into the water to remove all air.

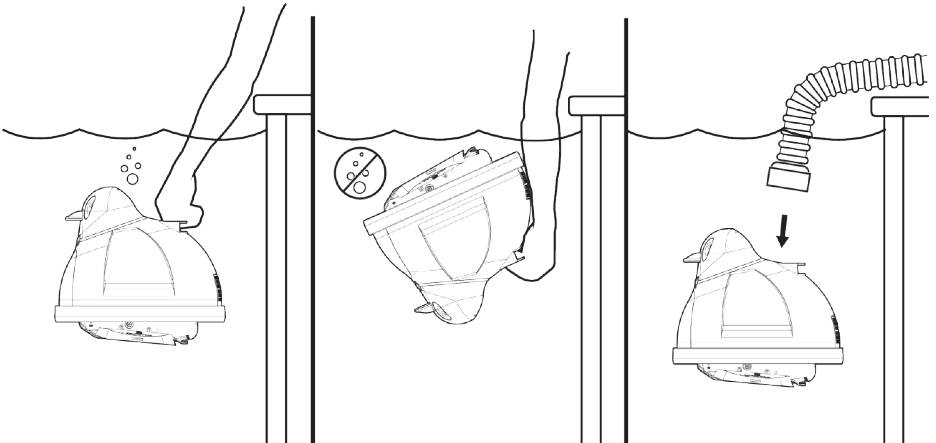



Step 7

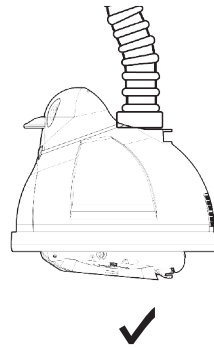
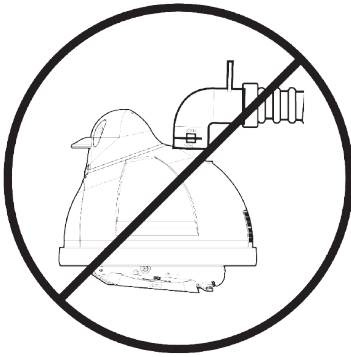
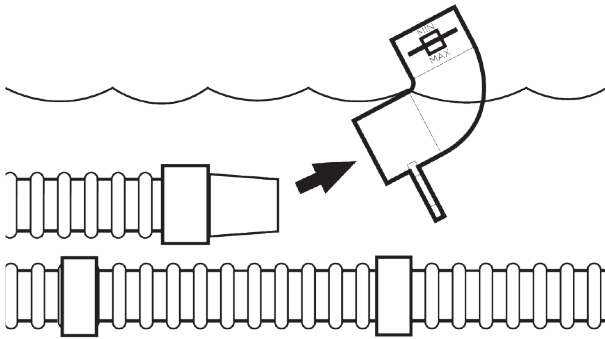

Step 8



Turn pump on and observe cleaner.

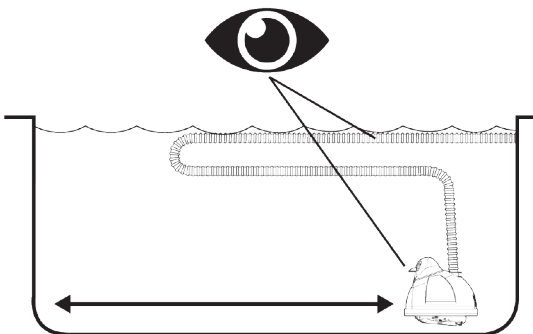

IMPORTANT TIPS



Periodically check the water flow/vacuum to be sure that your cleaner is operating as efficiently as possible.

Remember, too much vacuum is just as bad as too little.



Periodically check to make sure that the cleaner hose is securely attached to its suction source (i.e. skimmer, wall connector, etc.).



Disconnect the cleaner hose from the suction source prior to “backwashing”, to prevent water flow restriction.



DO NOT COIL HOSE

When storing your cleaner, the hose sections must be stored straight. A coiled hose will create a memory in the hose that will impede the cleaner’s ability to move properly.



Coiled hoses are not covered under the Hayward warranty.



Adjust the water return toward the center of the pool so water circulation does not interfere with the cleaner’s pool coverage capability.

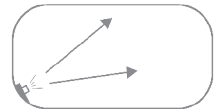
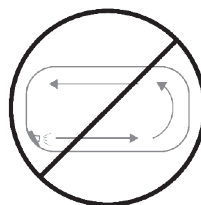
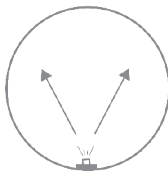
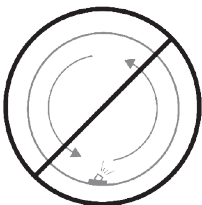

Use only original Hayward spare parts and hoses to ensure proper operation.



When the cleaner is out of the pool, always disconnect the leader hose from the cleaner.

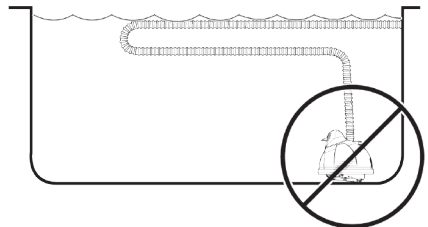
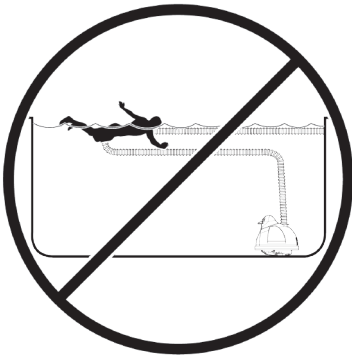
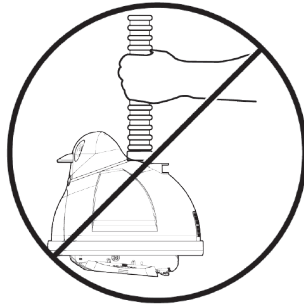
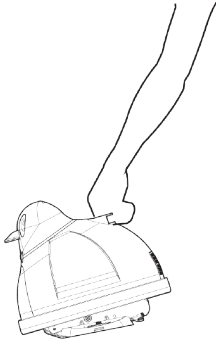

MAINTENANCE TIPS

Check the condition of the “shoes, wings, and flaps” periodically.

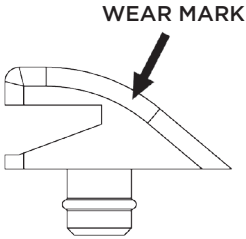

GOOD SHOE

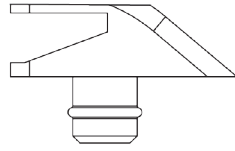

WORN SHOE

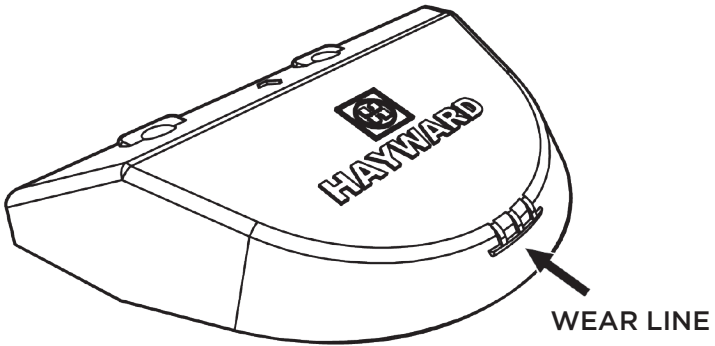

Hayward is not responsible for damage caused by misuse of the cleaner or damage caused by worn or broken parts.

Shoe Replacement:

Step 1

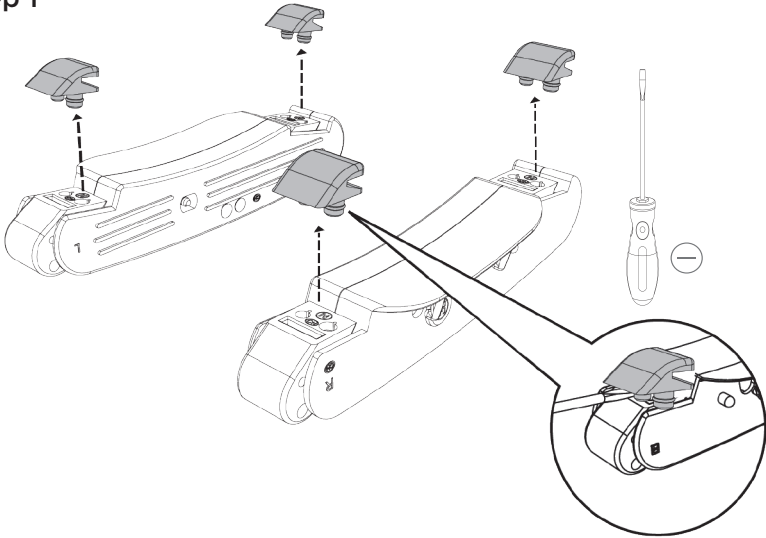

Step 2

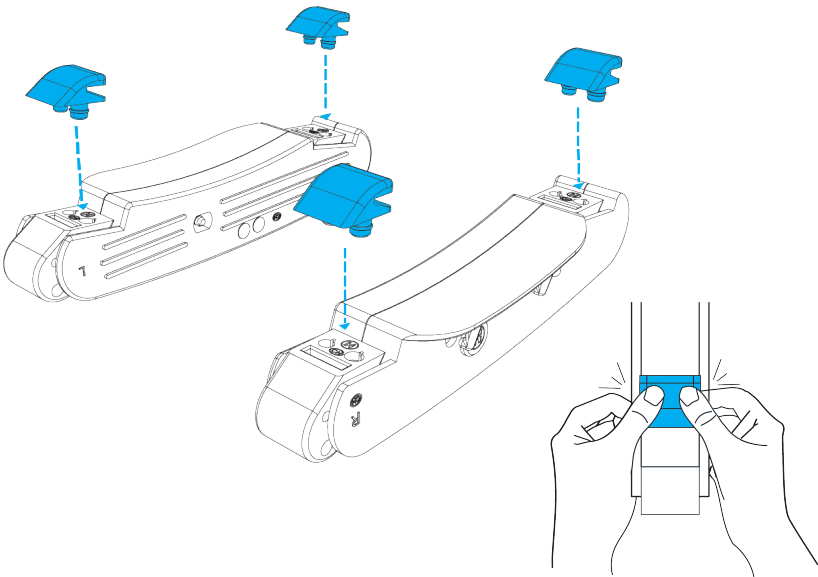

MAINTENANCE TIPS

Wing Replacement:

Step 1

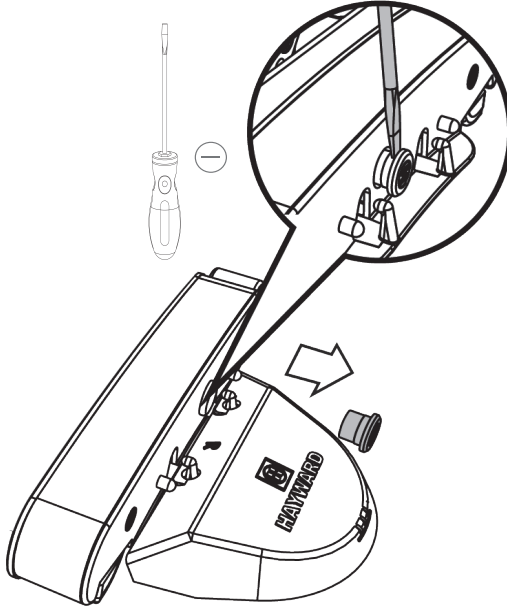

Step 2

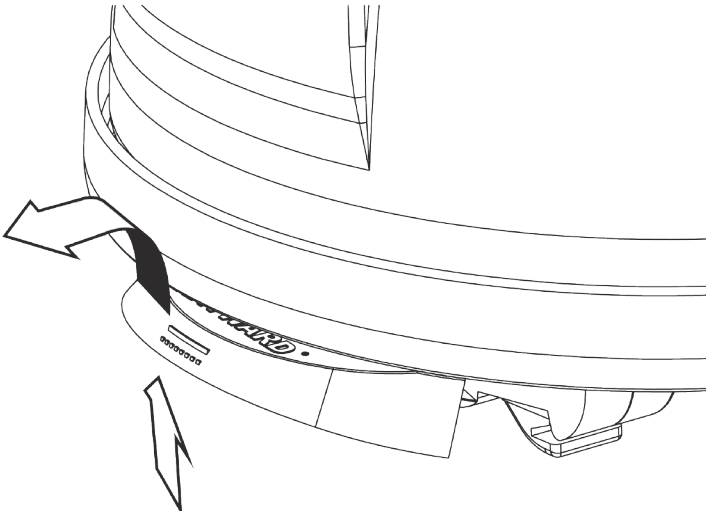

Step 3

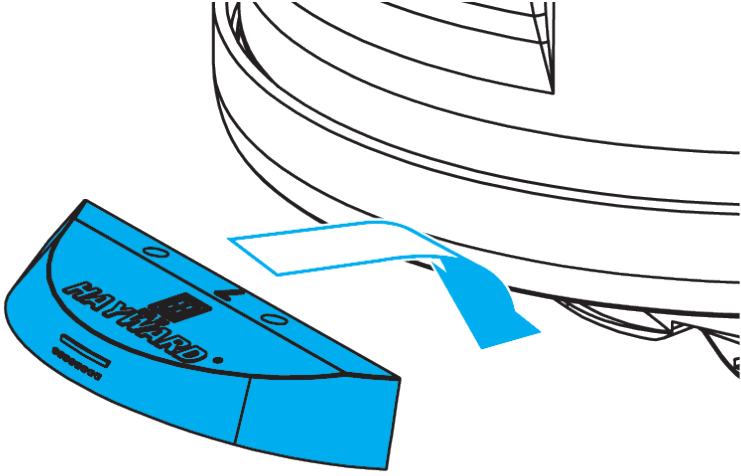

Step 4

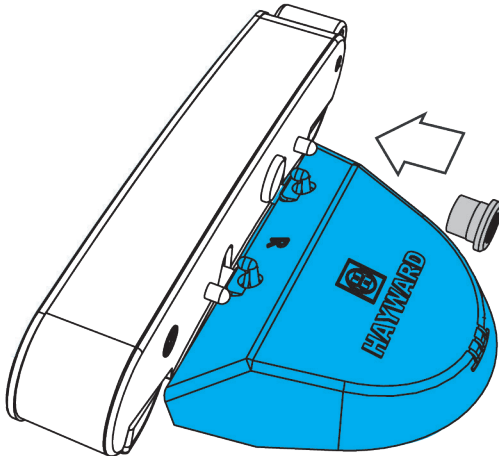

TROUBLESHOOTING

FOR TECHNICAL ASSISTANCE, CALL: 908.355.7995

PROBLEM	CAUSES	SOLUTION
Slow/no forward movement	Lack of/improper water flow through cleaner	Check water flow with flow gauge and adjust as per Step 5.
	Blockage of the cleaner throat	Clear blockage
	Worn shoes	Replace shoes
	Worn wings	Replace wings
	Improper cleaner model for application	See your pool dealer or servicer.
Cleaner head "floats"	Air trapped in the head	Remove all air from cleaner head. Stop all air from entering the pool through the return lines. If cleaner head and hose are covered with fine bubbles, give the hose a good tug. This will release the air bubbles and allow the cleaner head to settle to the bottom of the pool until the hose is covered with bubbles again.
	The cleaner head is actually being pulled or lifted off the bottom of the pool by the, or return line flow -either at the surface or at the bottom of the pool -or both.	Readjust return outlets to prevent water flow interfering with cleaner head and/or hose.

PROBLEM	CAUSES	SOLUTION
Cleaner sticks at ladder, corners, etc.	Improper water flow	Check water flow with flow gauge and adjust as per Step 5.
	Worn shoes	Replace shoes
	Worn wings	Replace wings
	Hose too short	Install additional hose sections per installation instructions.
	Steering failure	<ol style="list-style-type: none"> 1. Check and clean rear screen, if necessary 2. Check to see that cone gear is free of debris and rotates smoothly in both directions 3. Check steering program and troubleshoot –then: <ol style="list-style-type: none"> a. clean, repair or replace gearbox b. check pod/A-frame connection and REPLACE IF NECESSARY. DO NOT ATTEMPT TO RETIGHTEN LOOSE PODS. c. check medium turbine and spindle gear assemblies

WARRANTY

A limited warranty program protects your HAYWARD ABOVE GROUND SERIES cleaner. To take full advantage of the limited warranty, please read, complete and return registration card within 10 days of the purchase date. Your warranty card is packed in the owner's guide and accessory pack.

HAYWARD POOL PRODUCTS LIMITED WARRANTY

To original purchasers of this equipment, Hayward Pool Products warrants these cleaners to be free from defects in materials and workmanship for a period of TWO (2) years from the date of purchase, when used in single family residential applications.

The limited warranty excludes damage from freezing, negligence, improper installation, improper use or care or any Acts of God. Parts that fail from a defect or become defective during the warranty period shall be repaired or replaced, at our option, within 90 days of the receipt of defective product, barring unforeseen delays, without charge.

Proof of purchase is required for warranty service. In the event proof of purchase is not available, the manufacturing date of the product will be the sole determination of the purchase date.

To obtain warranty service, please contact the place of purchase or the nearest Hayward Authorized Service Center. For assistance on your nearest Hayward Authorized Service Center, please visit us at www.hayward.com.

Hayward shall not be responsible for cartage, removal, repair or installation labor or any other such costs incurred in obtaining warranty replacements or repair.

The Hayward Pool Products warranty does not apply to components manufactured by others. For such products, the warranty established by the respective manufacturer will apply.

The express limited warranty above constitutes the entire warranty of Hayward Pool Products with respect to its pool products and is in lieu of all other warranties expressed or implied, including warranties of merchantability or fitness for a particular purpose. In no event shall Hayward Pool Products be responsible for any consequential, special or incidental damages of any nature.

Some states do not allow a limitation on how long an implied warranty lasts, or the exclusion of incidental or consequential damages, so the above limitation may not apply to you. This warranty gives you specific legal rights, and you may also have other rights, which vary from state to state.

REGISTRATION CARD

DETACH HERE: Fill out bottom portion completely and mail within 10 days of purchase/installation or register online.

WARRANTY REGISTRATION CARD

Register online at www.hayward.com

Please Print Clearly:

First Name _____

Last Name _____

Address _____

Country _____

Phone Number _____

Purchase Date _____

E-Mail Address _____

Serial Number _____

Model Number _____

Pool Capacity _____ (U.S. Gallons)

Please include me on all e-mail communications regarding Hayward® Equipment or promotions.

Mail to:

Hayward Pool Products
620 Division Street
Elizabeth, NJ 07201 USA

Attn: Warranty Dept

or REGISTER YOUR WARRANTY
ON-LINE AT WWW.HAYWARD.COM

Years Pool has been in service

< 1 yr 2-3 4-5 6-10 11-15 >15

Purchased from:

Builder Retailer Pool Service

Internet/Catalog

Company Name _____

Address _____

Country _____

Phone _____

Type of Pool:

Concrete/Gunite Vinyl Fiberglass

Other _____

New Installation Replacement

Installation for:

In Ground Above Ground Spa

Thank you for your purchase



Hayward Pool Products
620 Division Street, Elizabeth, NJ 07201 USA
908.351.5400 • www.hayward.com



POR ENCIMA DEL SUELO SERIES

Aspiradora para Albercas
Manual del Usuario

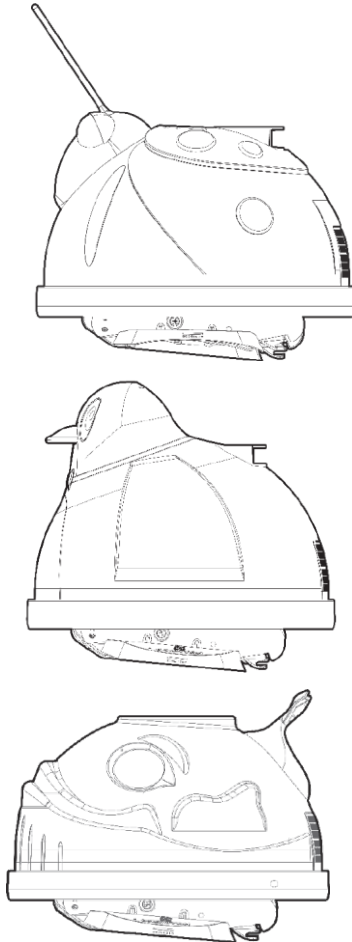

LIMPIADOR DE SUCCIÓN

Manual del Usuario

Felicidades por la compra de su sistema de limpieza automática Hayward. Si equipo es la forma inteligente y eficiente de limpiar su alberca de arriba abajo.

El limpiador de turbina Hayward funciona a través del sistema de filtrado de su alberca y funciona con la mayoría de los sistemas . El funcionamiento de su limpiador estará relacionado con su fuente de poder. Por esto existe la remota posibilidad de que sea necesario de hacer una llamada a servicio para completar la instalación del limpiador. Esta llamada a costo del consumidor.

Por último uno o más accesorios incluyendo mangueras adicionales podrían ser necesarias para la instalación. Consulte a su distribuidor Hayward para precios y disponibilidad.

PARA SUS REGISTROS

Fecha de compra:

Número de Serie:

ADEVERTENCIAS DE SEGURIDAD

NO lo use para remover escombros grandes en su alberca.

RETIRE el limpiador y las mangueras antes de agregar algún químico.

NO nade con el limpiador.

Guarde el limpiador en un área segura y con sombra.

NO enrolle las mangueras se tiene que guardar estiradas.

Mantenga fuera del alcance de niños y mascotas.

RETIRE el limpiador cuando haga retro lavado

RECUERDE La seguridad es primero.

Para más información visite www.hayward.com.

KEY



Consejo



Atención



Ajuste de Presión



Bomba



CONTENIDO

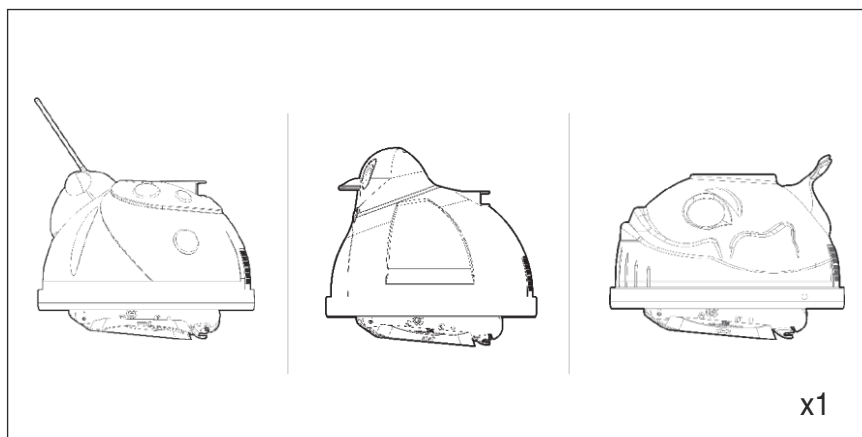

Limpiador de Alberca

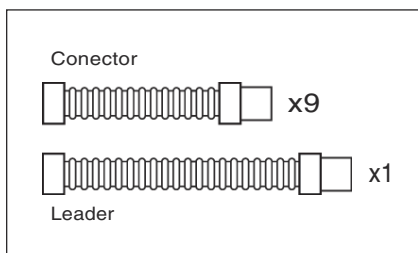

Conector/Manguera

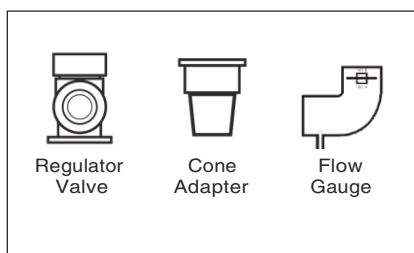

Accesorios

PREPARE LA ALBERCA

Complete los siguientes pasos para preparar la instalación:

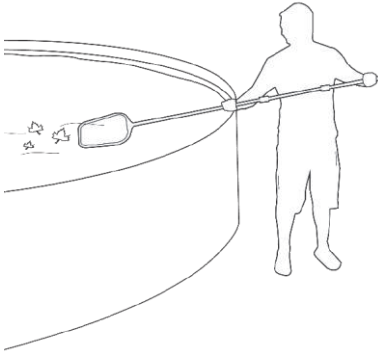

BASURA

Retire cualquier basura de su alberca.

NIVEL DE AGUA

Confirme que el nivel de agua sea el recomendado.

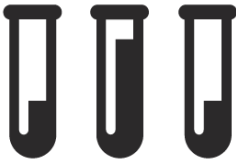

pH: 7.2 - 7.8
Cloro: 1.0-3.0 PPM
Alcalinidad Total: 80 - 120 PPM

QUÍMICA DEL AGUA

Asegúrese que el agua esté balanceada y libre de algas.

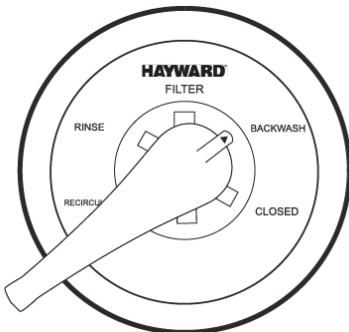

FILTRO

Limpe o haga retro lavado del filtro.

Limpe el desnatador y coladera de la bomba antes de instalar.

INSTALACIÓN

Mediar las Mangueras

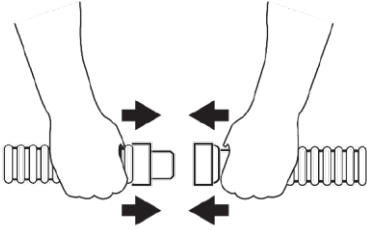

Paso 1

Conecte las secciones de mangueras.

Nota: Asegúrese de apretar bien las conexiones para evitar fugas.



TIP: *Humedecer los extremos de las mangueras hace que se conecten con facilidad.*



Si compró la canasta para hojas opcional, instale entre la manguera 1 y 2 empezando de la conexión a la pared.

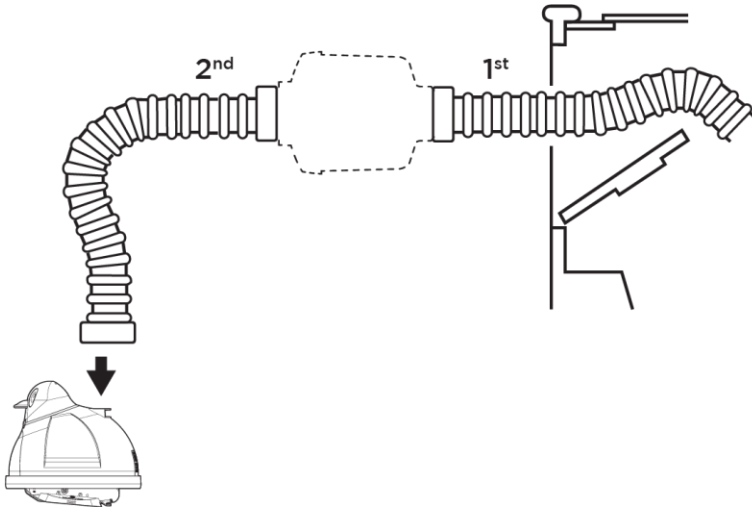

Paso 2

Extienda la manguera al punto más lejano de la alberca del lado opuesto al conector o colador + 2 secciones de manguera.

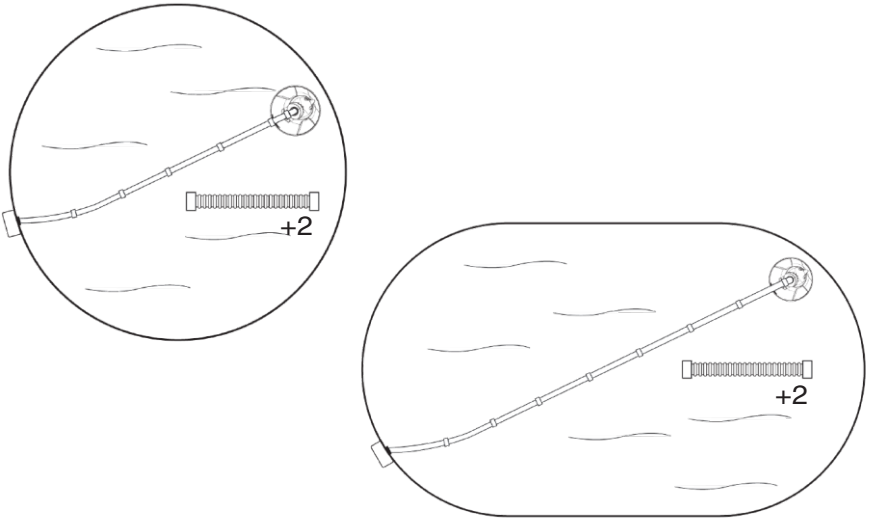

Paso 3



Llene la manguera con agua .
Inserte el medidor de flujo en la manguera líder. Coloque el C-clip en el medidor juntando con el primer tramo de manguera.

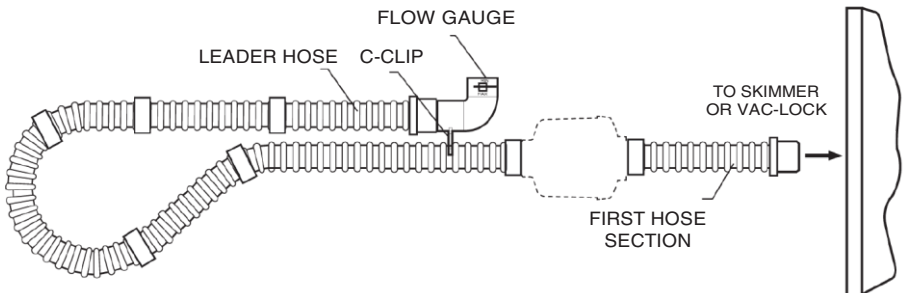

 Asegúrese que el medidor de flujo esté bajo agua.

INSTALACIÓN

Paso 4

Conecte al colador:

Conecte el cono adaptador al primer tramo de manguera.

Nota: El extremo de la manguera va en el codo adaptador.

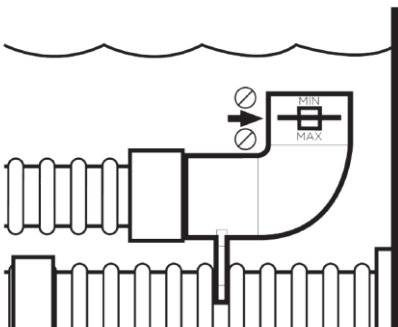
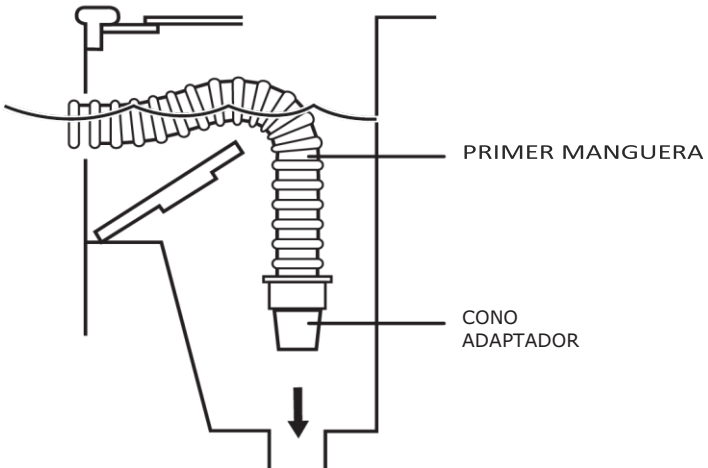

Paso 5



Cheque el flujo de agua en el medidor de flujo.

El disco negro debe estar entre las marcas "MIN" y "MAX" .

Si el disco está en la posición correcta siga al paso6.

Lectura Alta?

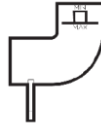

Si el disco negro está por fuera de la marca "MAX" y está conectada la manguera al colador, reduzca el flujo de agua/aspirado usando las siguientes opciones:

- Válvula de succión en el sistema del filtro (Si tiene una)
- Válvula reguladora Hayward.

Para instalar la válvula Hayward:



1. Quite la manguera del colador del cono adaptador.
2. Cierre la válvula reguladora gire el collar azul en sentido del reloj hasta que apriete.
3. Inserte la válvula reguladora en el cono adaptador del colador y el extremo de la manguera en la válvula reguladora.
4. Encienda el sistema de filtrado y deje que salga el aire del sistema.
5. Gire el collar azul hasta que el disco negro aparezca entre las marcas de "MIN" y "MAX" .

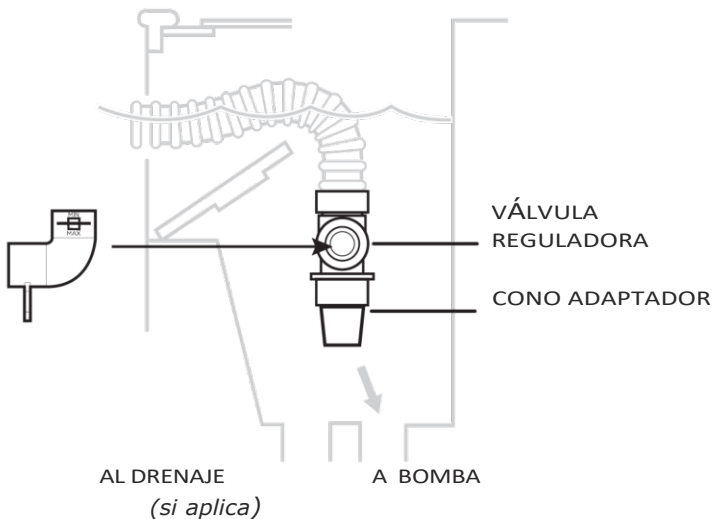

INSTALACIÓN

LEA MUY BAJO?

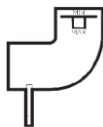

Una lectura inicial muy baja para alcanzar el nivel de flujo de agua necesario para operar el limpiador, indica que hay un problema en sistema, no en el limpiador

La válvula reguladora no se puede usar para INCREMENTAR la lectura inicial de aspirado

Visite YouTube video en
www.youtube.com/watch?v=aqyrv_9nJZI
o contacte un centro autorizado Hayward
para asistencia.

PASO 6

Sumerja el limpiador en el agua para remover todo el aire.

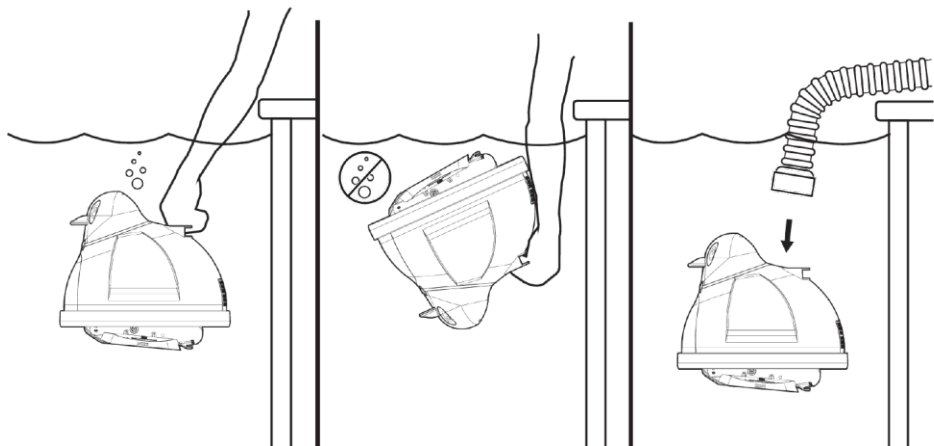



Paso 7

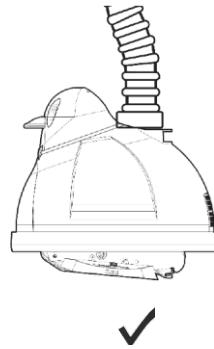
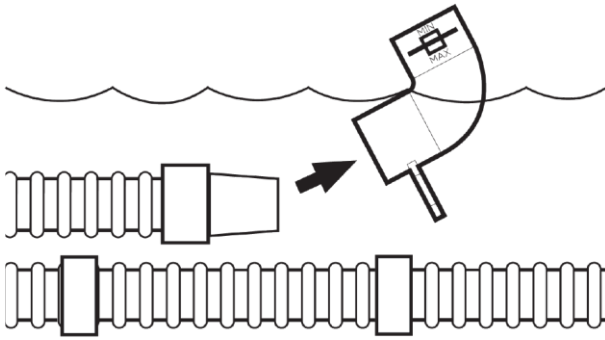

Paso 8

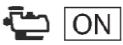

Prenda la Bomba y observe el Limpiador.

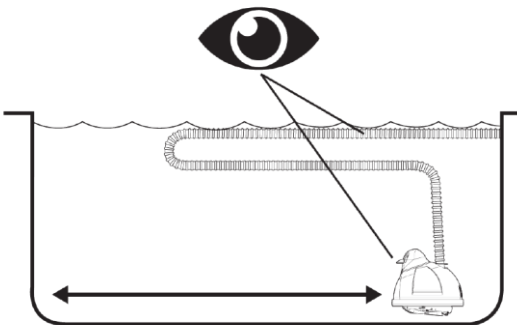

CONSEJOS IMPORTANTES



Periódicamente cheque el flujo de agua/aspirado para estar seguro que su limpiador esté funcionando bien.

Recuerde mucho aspirado es tan malo como poco..



Periódicamente cheque que la manguera este bien conectada a la fuente de succión (colador, conexión a la pared, etc.).



Desconecte la manguera del limpiador de la fuente de succión antes de hacer el retrolavado, para prevenir restricción en el flujo de agua.



NO ENROLLE LA MANGUERA

Cuando almacene su limpiador, las secciones de manguera se deben guardar estiradas. una manguera doblada pierde la habilidad de moverse propiamente.



Mangueras enrolladas pierden la garantía de Hayward.



Ajuste que el agua regrese al centro de la alberca para que la circulación del agua no interfiera con la capacidad de cobertura del limpiador.

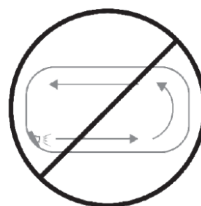
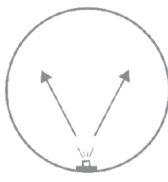
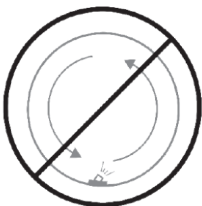

Use solamente partes y refacciones originales Hayward para un mejor operación.



Cuando el limpiador esté fuera de la alberca, desconecte la manguera del limpiador.

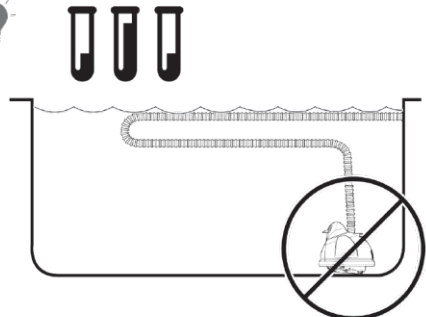
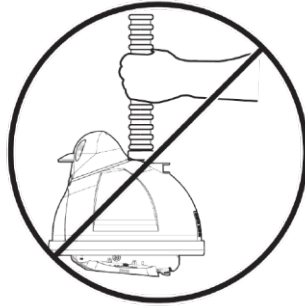

CONSEJOS DE MANTENIMIENTOS

Cheque la condición de zapatas, aletas, ("shoes, wings, and flaps") periódicamente.

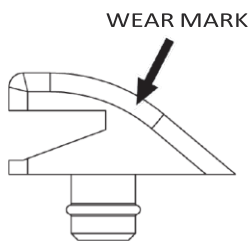

GOOD SHOE

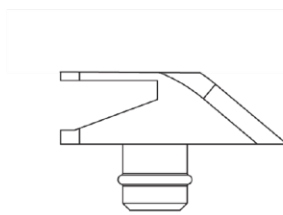

WORN SHOE

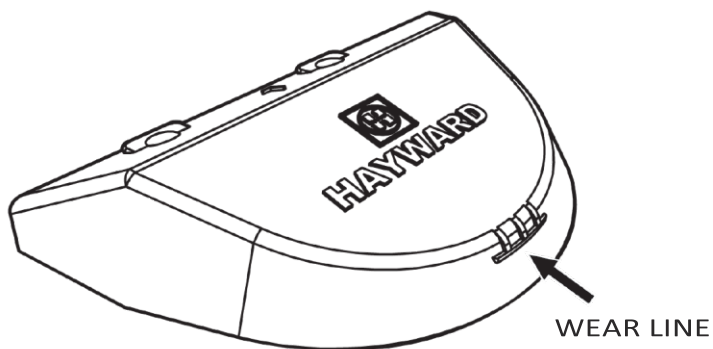

Hayward no es responsable por daños causador por mal uso del limpiador o daños causados por partes gastadas o rotas .

Remplazo de la zapata:

Step 1

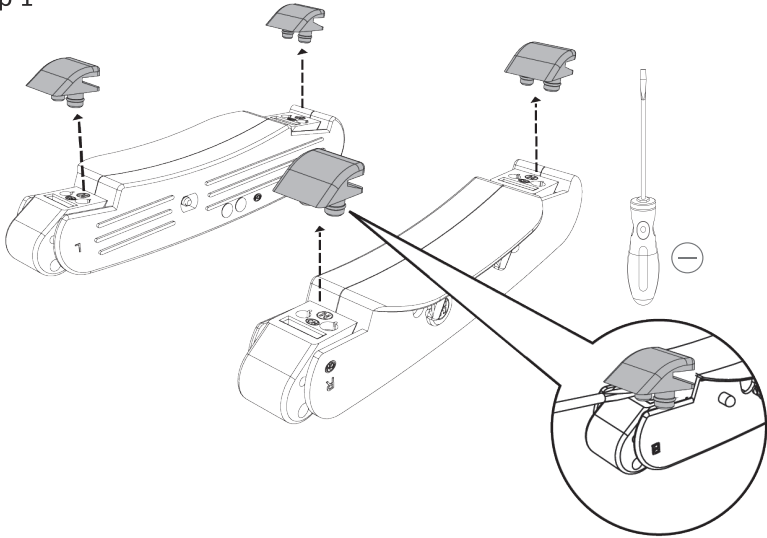

Step 2

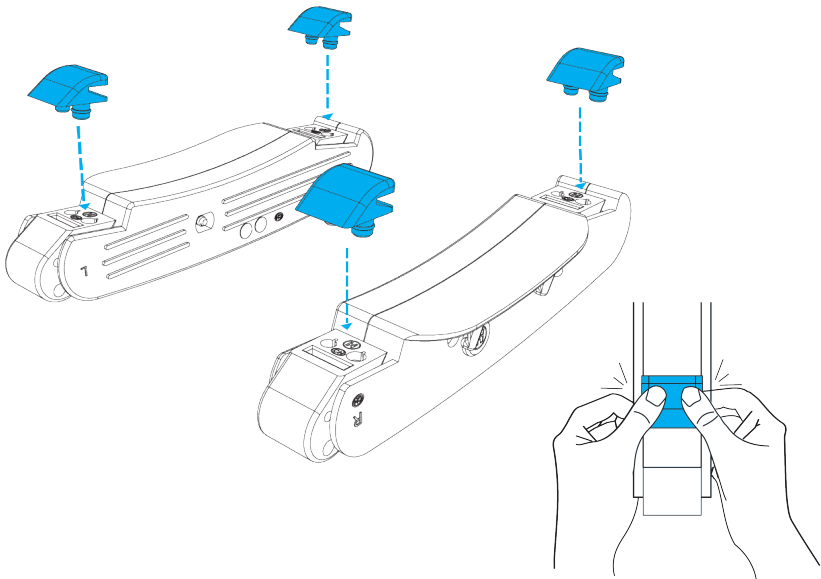

CONSEJOS DE MANTENIMIENTOS

Remplazo de la aleta:

Step 1

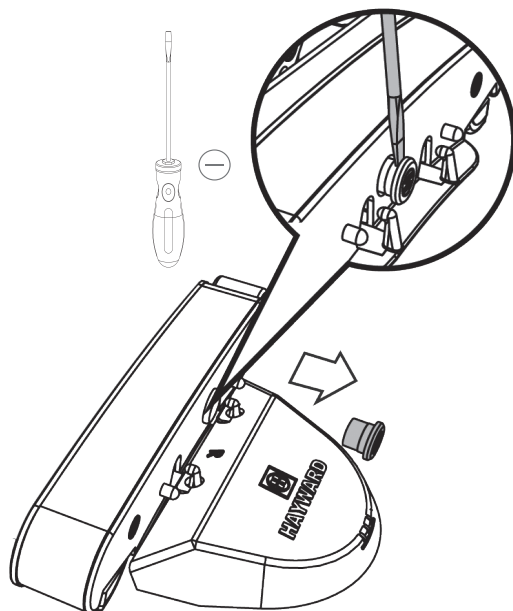

Step 2

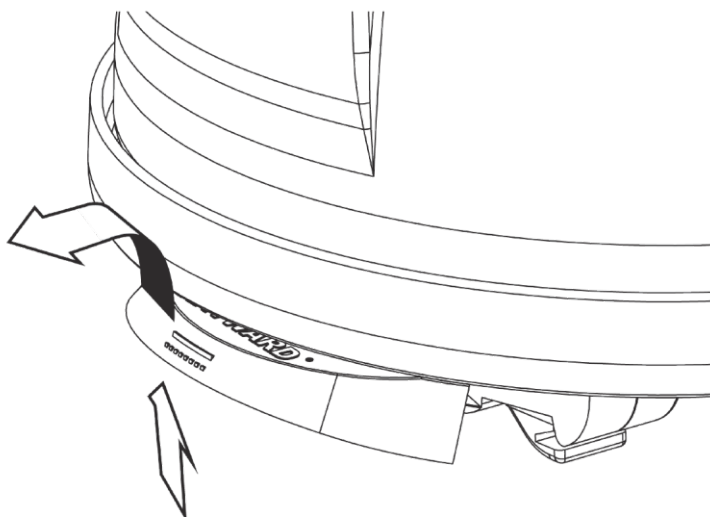

Step 3

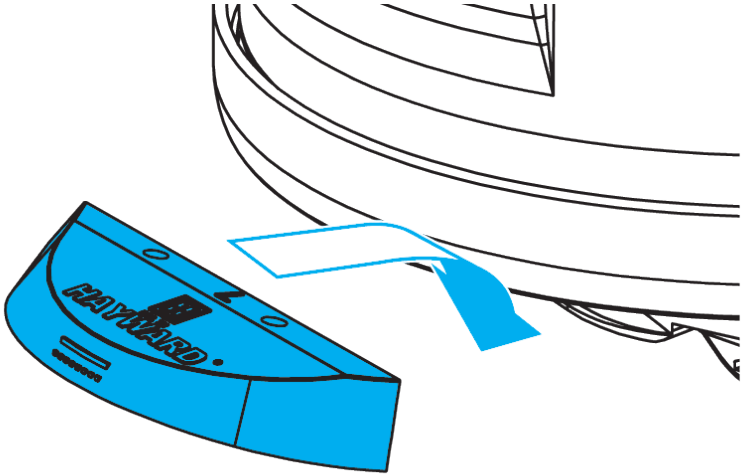

Step 4

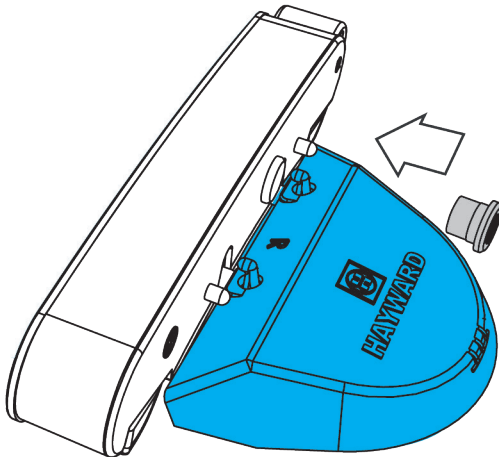

SOLUCIÓN DE PROBLEMAS

PARA ASISTENCIA TÉCNICA, LLAME: 908.355.7995

PROBLEMA	CAUSA	SOLUCIÓN
No se mueve o se mueve muy despacio	Falta /impropio flujo de agua a través del limpiador	Cheque el flujo del agua con un medidor, y ajuste Paso 5.
	La entrada del Limpiador está bloqueada	Desbloquee
	Zapata desgastada	Reemplace zapata
	Aleta desgastada	Reemplace aleta
	Modelo de limpiador inapropiado	Consulte se centro de servicio.
La cabeza del limpiador flota	Aire atrapado en la cabeza del limpiador	Remueva el aire de la cabeza. Detenga todo el aire que entra a la alberca por las líneas de regreso. De un buen tirón a la manguera para quitar las burbujas y dejar que el limpiador se asiente en el fondo de la alberca. hasta que la manguera se llene de burbujas otra vez.
	La cabeza del limpiador es jalada del fondo de la alberca por el flujo de la línea de regreso .	Reajuste las salidas de regreso para prevenir que el flujo de agua interfiera con el limpiador o mangueras.

PROBLEMA	CAUSA	SOLUCIÓN
El Limpiador se atora en escaleras esquinas, etc.	Impropio flujo de agua	Cheque el flujo de agua con un medidor y ajuste , Paso 5.
	Zapata desgastada	Reemplace zapata
	Aleta desgastada	Replase aletas
	Manguera muy corta	Instale una sección de manguera adicional
	Falla en la dirección	<ol style="list-style-type: none"> 1. Cheque y limpie la reja de atrás 2. Cheque que el cono esté libre de escombros y se mueva suavemente. 3. Cheque el programa de dirección: <ol style="list-style-type: none"> a. limpie, repare o cambie transmisión b. cheque la conexión del pod/A y cambie si es necesario. DO NOT TRATE DE APRETAR SI ESTA FLOJO EL PODS. c. cheque la turbina y el eje de la dirección

GARANTIA

Una garantía limitada protege su limpiador HAYWARD ABOVE GROUND SERIES. Para tomar completa ventaja de su garantía por favor lea, complete y regrese la tarjeta de registro(registration card) dentro de los primeros 10 días de su fecha de compra. Su tarjeta de garantía está dentro del manual del usuario.

HAYWARD POOL PRODUCTS GARANTÍA LIMITADA

A los compradores originales de este equipo, Hayward Pool Products, Inc. Garantiza que sus productos carecen de defectos en los materiales y en la mano de obra durante un periodo de dos años (2) a partir de la fecha de compra , para el uso residencial de una sola familia.

La garantía limitada excluye daños por congelación, negligencia , instalación inadecuada, uso o cuidados inadecuados, o cualquier Acto de Dios. Las partes que fallen o que se vuelvan defectuosas durante el periodo de la garantía, serán reparadas o remplazadas a opción nuestra, sin cargo alguno en los siguientes 90 días después de recibir el producto defectuoso, salvo demoras imprevistas.

Se requiere el comprobante de compra para obtener la garantía de servicio. En el caso que no tenga el recibo de compra, la fecha de fabricación del producto será la que determine la fecha de compra.

Para obtener la garantía de servicio, por favor contacte el lugar de compra o el Centro de Servicio Autorizado Hayward más cercano. Para asistencia sobre su Centro de Servicio Autorizado Hayward más cercano visítenos en www.hayward.com .

Hayward no se hará responsable de los costos de transporte, del costo de mano de obra necesaria para la remoción y /o reinstalación, ni de ningún otro costo de este tipo incurridos para obtener los repuestos bajo garantía.

La garantía de Hayward Pool Products no se aplica a los componentes fabricados por otras compañías. Para dichos productos, se aplicará la garantía establecida por los fabricantes respectivos.

La garantía limitada exprés descrita anteriormente, constituye la garantía completa de Hayward Pool Products con respecto a sus productos para albercas y será en vez de cualquier otra garantía expresada o implícita incluyendo garantías de comerciabilidad o conveniencia para algún propósito en particular. En ningún caso Hayward Pool Products será responsable por cualquier consecuencia especial por accidente o daños naturales.

Algunos estados no permiten que se pongan limites en la duración de la garantía implícita, o que se excluyan o limiten los daños incidentales o consecuentes; por lo tanto, es posible que la limitación o exclusión antes mencionada no corresponda en su caso. Esta garantía le da derechos legales específicos y Usted también podría tener otros derechos , los cuales varían de un estado a otro

TARJETA DE REGISTRO

DESPRENDA AQUI: Llene la tarjeta de registro y envíela por correo dentro de los siguientes 10 días de la fecha de compra o regístrese por internet.

TARJETA DE REGISTRO DE GARANTIA

Regístrese en línea en: www.hayward.com

Por favor escriba claro:

Nombre _____

Apellido _____

Dirección _____

_____ O

País _____

Teléfono _____

Fecha de compra _____

Correo electrónico _____

Numero de serie _____

Numero de modelo _____

Capacidad de la alberca _____ (U.S. Galones)

Por favor incluyan mi correo electrónico en todas las promociones de los equipos Hayward®.

Envíe a:

Hayward Pool Products
620 Division Street
Elizabeth, NJ 07201 USA

Attn: Departamento de Garantías

o REGISTRE SU GARANTIA EN
LINEA EN WWW.HAYWARD.COM

Gracias por su compra

Años de la alberca en servicio

< 1 yr 2-3 4-5 6-10 11-15 >15

Compro en:

Constructora Tienda Servicio de albercas
 Internet/Catalogo

Nombre de la compañía _____

Dirección _____

País _____

Teléfono _____

Tipo de alberca:

Concreto/Granito Vinil Fibra de vidrio
Otra _____

Nueva Reemplazo

Instalación:

En tierra Sobrepuesta Spa



Hayward Pool Products
620 Division Street, Elizabeth, NJ 07201 USA
908.351.5400 • www.hayward.com



Nettoyeur automatique à aspiration pour piscine hors-sol. Manuel d'utilisation

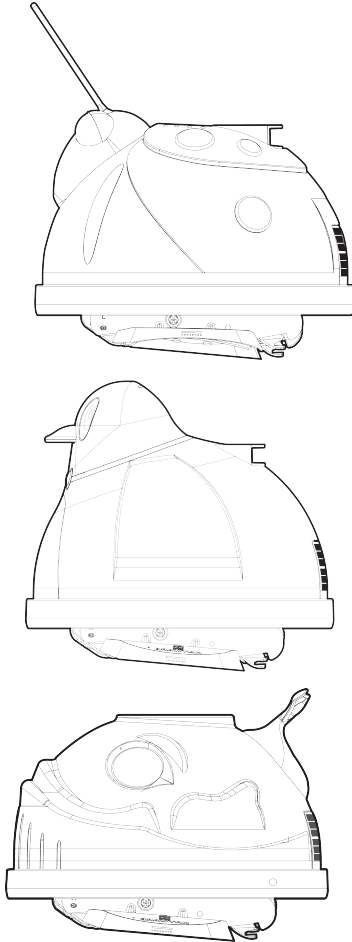

APPAREIL DE NETTOYAGE PAR ASPIRATION À TURBINE

Manuel d'utilisation

Félicitations pour l'achat de ce nettoyeur automatique à aspiration Hayward. Ce nettoyeur automatique Hayward est la solution la plus efficace et facile pour le nettoyage de votre piscine hors-sol.

Les appareils de nettoyage à turbine Hayward sont alimentés par le système de filtration de votre piscine et sont conçus pour fonctionner avec la plupart des systèmes. Les performances de l'appareil de nettoyage dans votre piscine dépendront de la performance de votre système de filtration. Parce que le fonctionnement et les performances de l'appareil de nettoyage sont dépendants du système de filtration, il se peut qu'un appel de service soit nécessaire afin de terminer complètement l'installation de votre nettoyeur. Cet appel sera aux frais du consommateur.

Enfin, il se peut que vous ayez besoin d'un ou de plusieurs des accessoires conçus pour votre nettoyeur, y compris de sections de tuyau supplémentaires, pour votre installation. Consultez votre concessionnaire Hayward pour les prix et la disponibilité.

POUR VOTRE DOSSIER

Date d'achat :

Numéro de série :

AVERTISSEMENTS DE SÉCURITÉ

NE PAS utiliser pour nettoyer une nouvelle piscine contenant des débris de grande taille.

RETIRER l'appareil de nettoyage et le tuyau avant TOUT ajout de produits chimiques dans votre piscine.

NE PAS se baigner lorsque l'appareil de nettoyage est dans la piscine.

Entreposer l'appareil de nettoyage dans un lieu sûr et à l'ombre.

Les tuyaux doivent être maintenus droits pour l'entreposage. **NE PAS** enrouler le tuyau.

MAINTENIR HORS DE PORTÉE des enfants et des animaux domestiques. **CE NETTOYEUR AUTOMATIQUE N'EST PAS UN JOUET.**

RETIRER l'appareil de nettoyage lors d'un lavage à contre-courant.

NE PAS OUBLIER que la sécurité passe avant tout.

Pour des informations complètes sur les avertissements et la sécurité, rendez-vous sur la page www.hayward.com.

LÉGENDE



Conseil



Réglage de la pression



Attention



Pompe



CONTENU DU CARTON

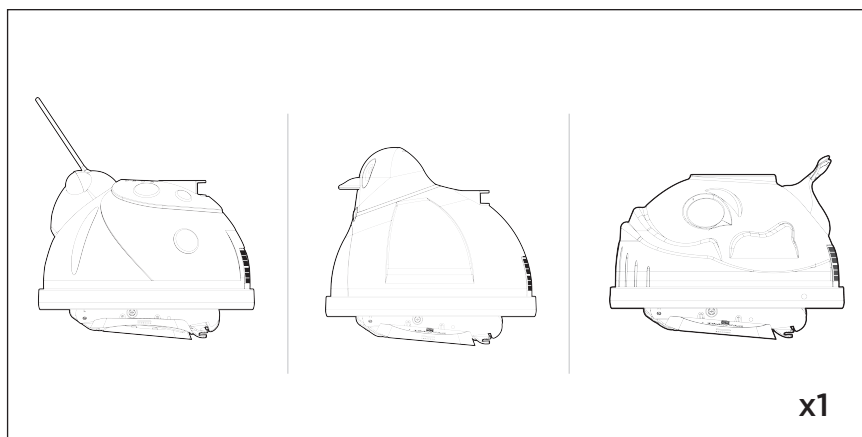

Nettoyeur automatique

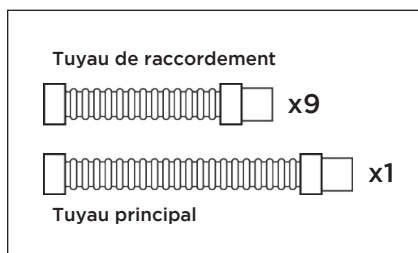

Tuyaux de raccordement et tuyau principal

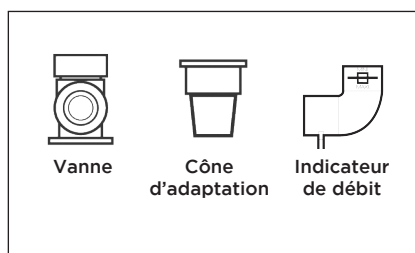

Kit d'accessoires

PRÉPARATION DE LA PISCINE

Suivre les étapes décrites ci-dessous afin de préparer la piscine pour l'installation :

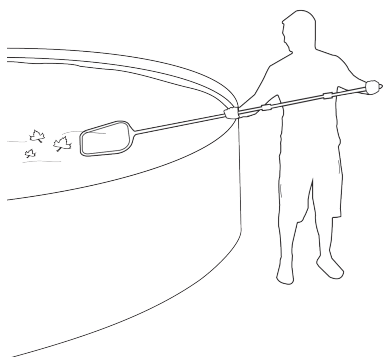

DÉBRIS

Retirer de la piscine tout débris et objet de grande taille.

NIVEAU DE L'EAU

S'assurer que le niveau d'eau est conforme aux recommandations.

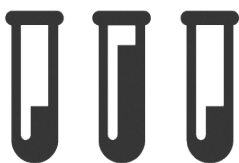

pH : 7,2 - 7,8
Chlore : 1,0 - 3,0 ppm
Alcalinité totale : 80 - 120 ppm

COMPOSITION CHIMIQUE DE L'EAU

S'assurer que la composition de l'eau est bien équilibrée et que la piscine est exempte d'algues.

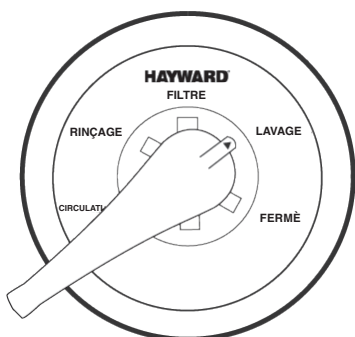

FILTRE

Nettoyer ou laver à contre-courant le filtre (lavage).

Nettoyer le panier de la pompe et de l'écumoire avant d'installer l'appareil de nettoyage.

INSTALLATION

Dimensionner le tuyau d'aspiration

Étape 1

Relier les sections de tuyau.

Remarque : s'assurer que tous les raccords sont bien serrés pour empêcher toute aspiration d'air.

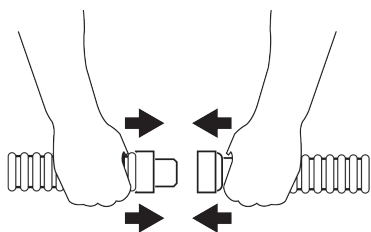

CONSEIL : *il sera plus facile de raccorder les sections de tuyau en mouillant leurs extrémités.*



Si le piège à feuilles en option est acheté, l'installer entre la première et la deuxième section de tuyau, à partir de l'écumoire.

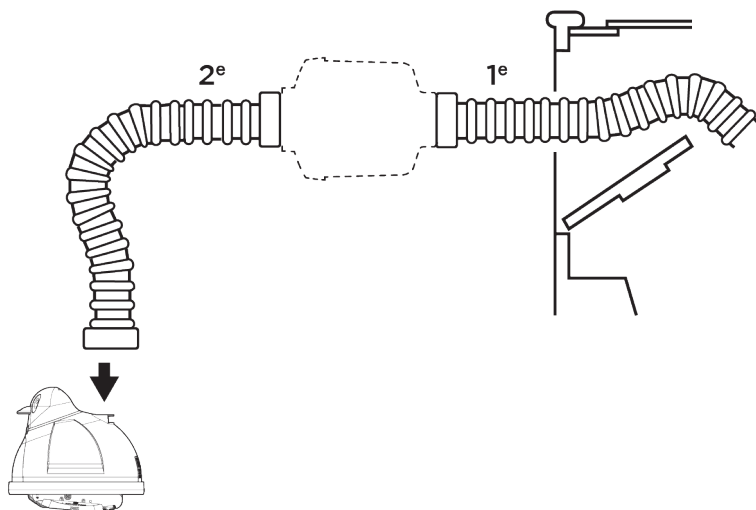

Étape 2

Étirer le tuyau vers l'emplacement le plus éloigné de la piscine en face de l'écumoire ou du raccord de la paroi + 2 sections de tuyau supplémentaires.

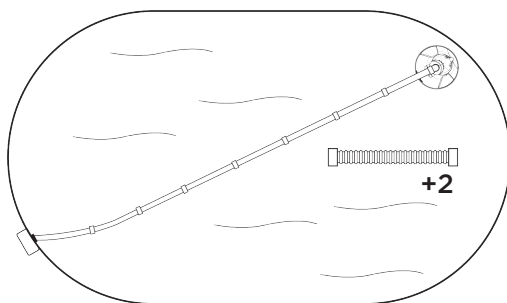
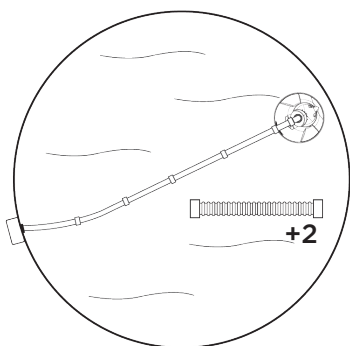

Étape 3



Remplir entièrement le tuyau avec de l'eau. Insérer l'indicateur de débit à l'extrémité du tuyau principal. Fixer l'agrafe en C de l'indicateur sur la première section de tuyau.

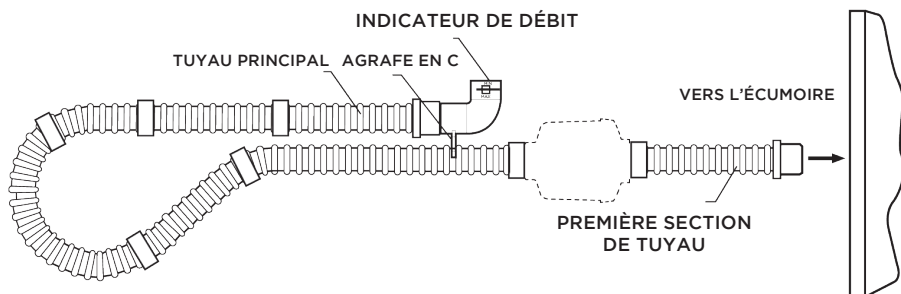

 l'indicateur de débit doit être immergé.

INSTALLATION

Étape 4

Branchement vers l'écumoire :

Raccorder le cône d'adaptation à l'extrémité mâle conique de la première section du tuyau.

Remarque : l'extrémité du tuyau s'insère dans le cône d'adaptation.

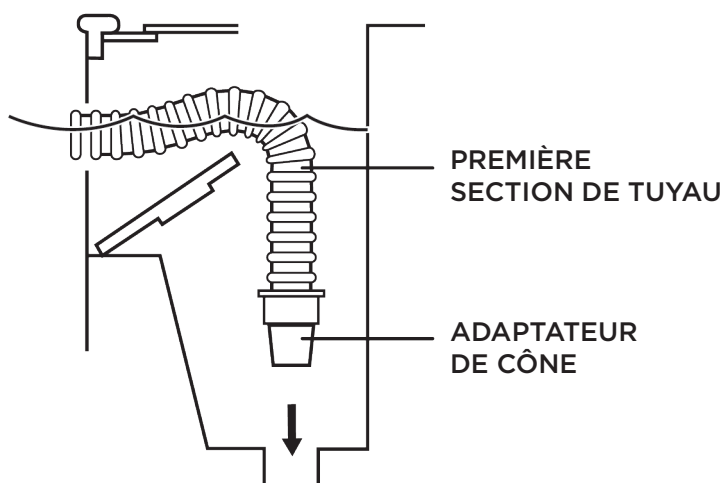

Étape 5

Contrôler le débit de l'eau sur l'indicateur de débit.

Le disque noir doit indiquer entre le « MIN. » et « MAX. ».

Si le disque est au bon endroit, passer à l'étape 6.

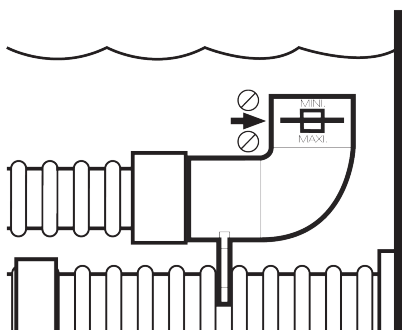

Niveau trop élevé?

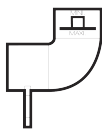

Si le disque noir dépasse la marque « MAX. » et que vous avez branché votre tuyau à l'écumoire, il vous faudra réduire le débit d'eau à l'aide :

- de la valve d'aspiration du système de filtration (s'il en est équipé)
- de la vanne Hayward

Pour installer la vanne Hayward :



1. Retirer le tuyau de l'écumoire.
2. Fermer la vanne en tournant la bague bleue dans le sens des aiguilles d'une montre.
3. Insérer la vanne dans le cône d'adaptation et l'extrémité du tuyau dans la soupape de réglage.
4. Mettre en route le système de filtrage pour lui permettre d'éliminer complètement l'air dans le système.
5. Tourner la bague bleue dans le sens des aiguilles d'une montre jusqu'à ce que le disque noir soit entre les inscriptions « MIN. » et « MAX. ».

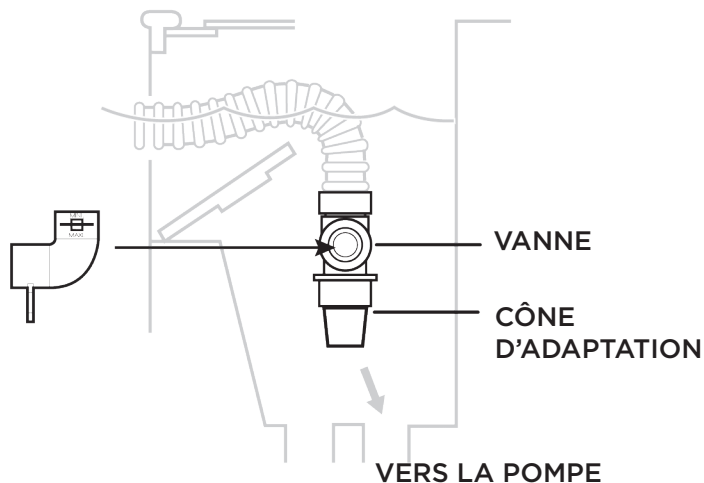

INSTALLATION

Niveau trop bas

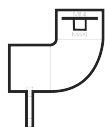

Une valeur d'aspiration initiale TROP basse pour être conforme au réglage du débit d'eau nécessaire pour faire fonctionner le nettoyeur correctement signifie que le système de filtration ne procure pas le débit suffisant et non pas qu'il y a un problème lié à l'appareil de nettoyage.

La vanne ne peut pas être utilisée pour AUGMENTER le débit du système.

Contactez votre concessionnaire Hayward agréé pour obtenir de l'aide.

Étape 6

Immerger l'appareil de nettoyage dans l'eau pour éliminer complètement l'air.

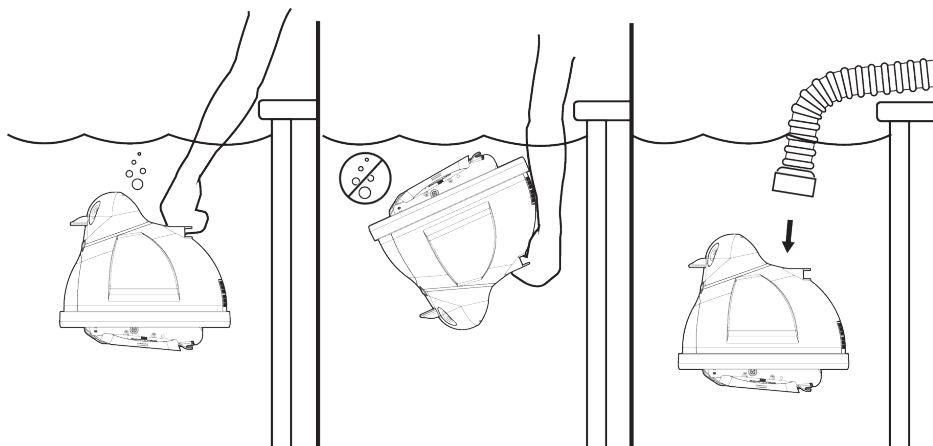

Étape 7

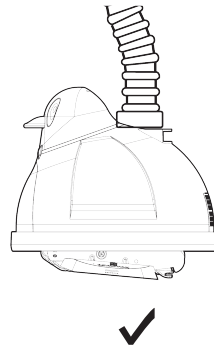
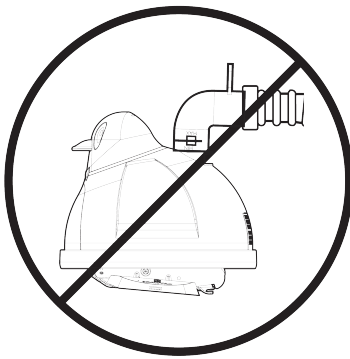
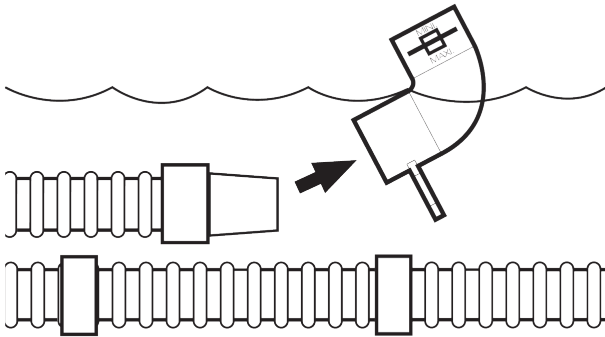

Étape 8

Mettre en marche la pompe puis observer le fonctionnement du nettoyeur.

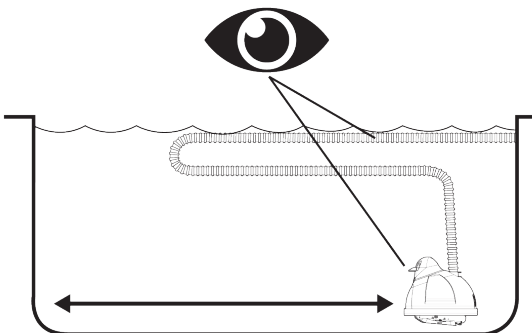

CONSEILS IMPORTANTS



Vérifier régulièrement le débit d'eau pour être certain que le nettoyeur fonctionne aussi efficacement que possible.

Ne pas oublier que trop de débit est tout aussi mauvais que trop peu.



Vérifier régulièrement que le tuyau du nettoyeur est correctement relié à sa source d'aspiration (c.-à-d. à l'écumoire)



Débrancher le tuyau du nettoyeur de l'écumoire/de la vanne avant le « lavage », pour ne pas limiter le débit d'eau.



NE PAS ENROULER LE TUYAU

Lors du stockage du nettoyeur, les sections de tuyau doivent être maintenues droites. Un tuyau enroulé conserve cette forme et empêchera le nettoyeur de se déplacer correctement.

Les tuyaux enroulés ne sont pas couverts par la garantie Hayward.

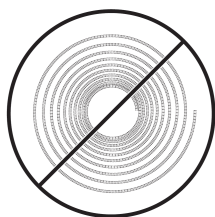

Diriger le courant de retour de l'eau vers le centre de la piscine afin que la circulation de l'eau ne limite pas la capacité de nettoyage de l'appareil.

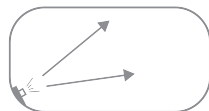
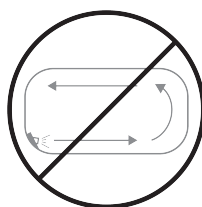
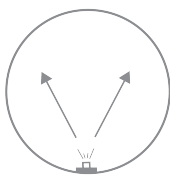
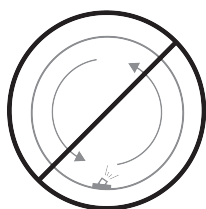

Utiliser uniquement des tuyaux et des pièces de rechange d'origine Hayward pour assurer un fonctionnement adéquat.



Lorsque le nettoyeur n'est pas dans la piscine, débrancher toujours le tuyau principal de celui-ci.

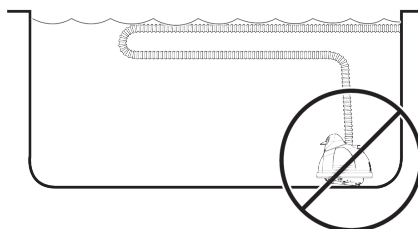
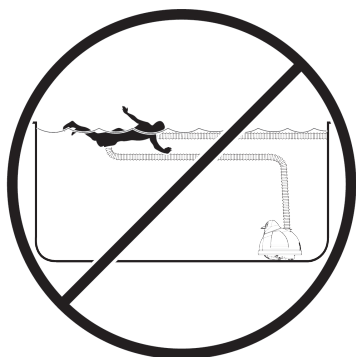
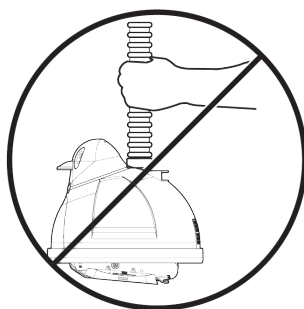
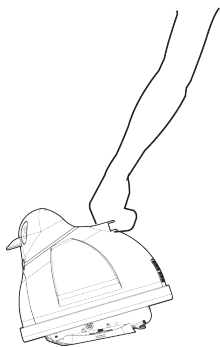

CONSEILS D'ENTRETIEN

Vérifier régulièrement l'état des « semelles, ailes et volets »

INDICATEUR D'USURE

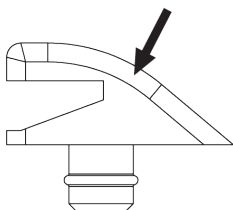

SEMELLE CORRECTE

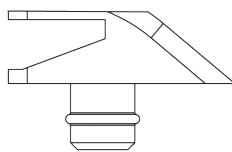

SEMELLE USÉE

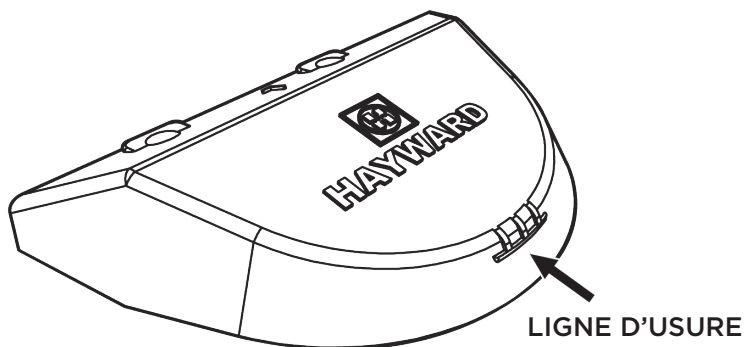

Hayward n'est pas responsable des dommages causés par une mauvaise utilisation de l'appareil de nettoyage ou par des pièces usées ou brisées.

Remplacement des semelles :

Étape 1

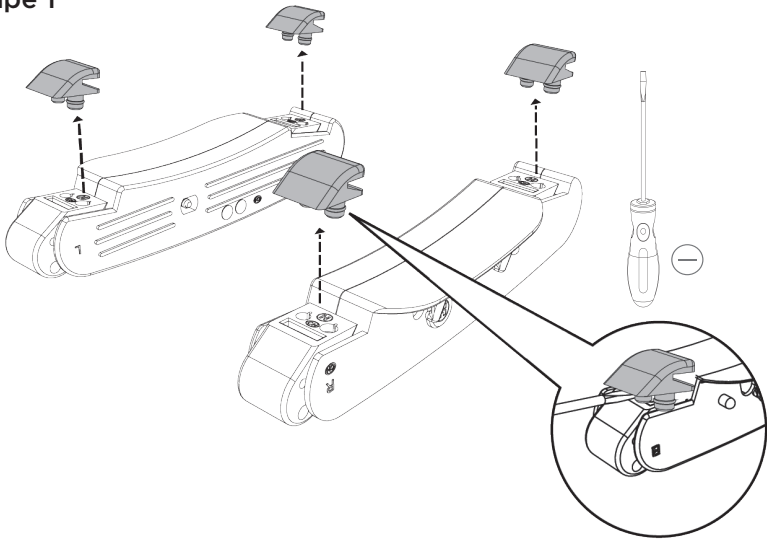

Étape 2

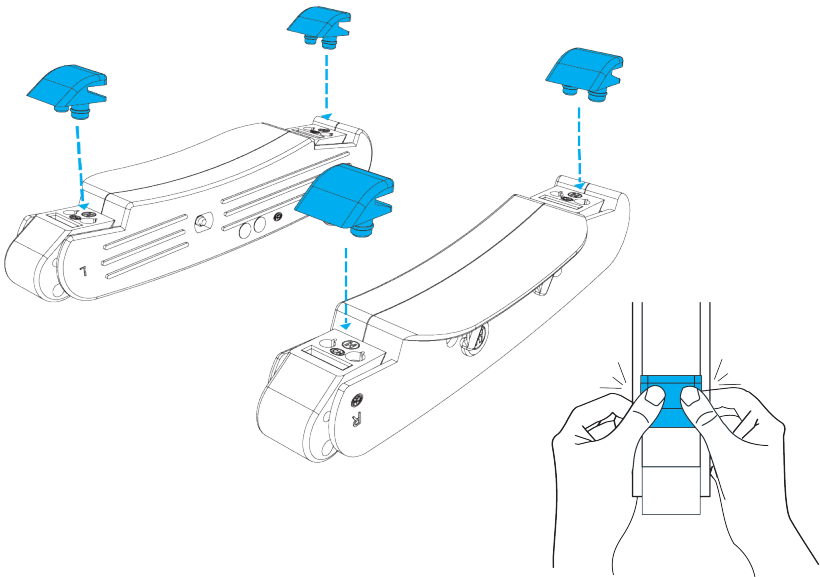

CONSEILS D'ENTRETIEN

Remplacement des ailes :

Étape 1

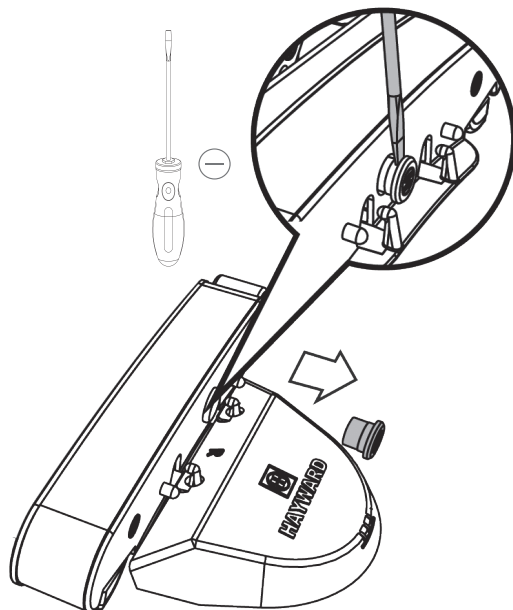

Étape 2

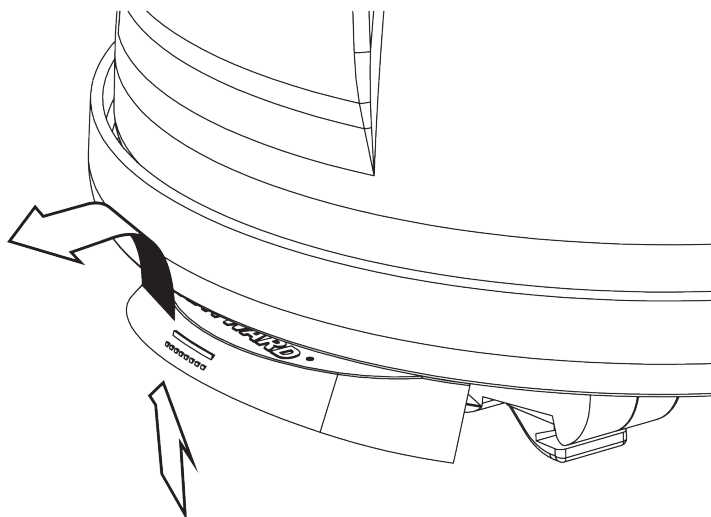

Étape 3

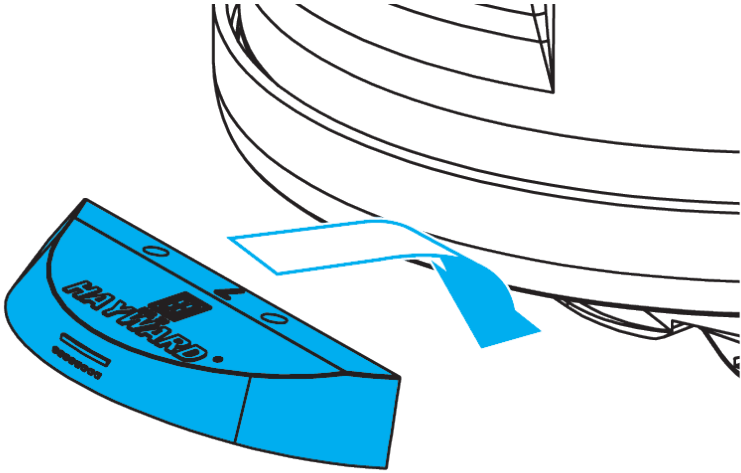

Étape 4

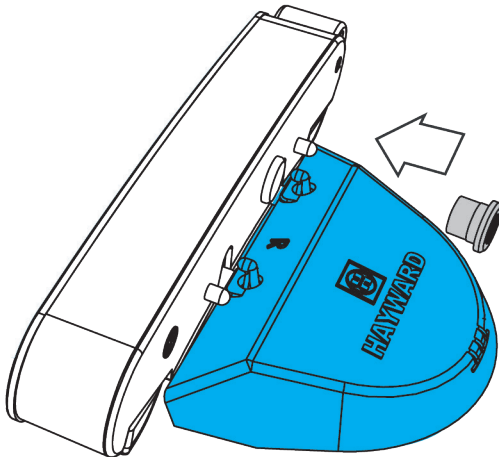

DÉPANNAGE

POUR DEMANDER UNE ASSISTANCE TECHNIQUE, APPELER LE : 908.355.7995

PROBLÈME	CAUSES	SOLUTION
Aucun mouvement vers l'avant ou mouvement vers l'avant est lent	Débit d'eau manquant ou inadéquat dans l'appareil de nettoyage	Vérifier le débit de l'eau à l'aide de l'indicateur de débit puis le régler comme indiqué à l'étape 5.
	Obstruction de la gorge de l'appareil de nettoyage	Dégager l'obstruction
	Semelles usées	Remplacer les semelles
	Ailes usées	Remplacer les ailes
	Modèle d'appareil de nettoyage inadéquat pour l'application	Consulter un concessionnaire de piscines ou un dépanneur.
La tête de l'appareil de nettoyage « flotte »	Air piégé dans la tête de l'appareil de nettoyage	Retirer tout l'air de la tête de l'appareil de nettoyage. Empêcher l'air d'entrer dans la piscine par les conduites de retour. Si de fines bulles couvrent la tête de l'appareil de nettoyage et le tuyau, tirer vigoureusement ce dernier. Cela libèrera les bulles d'air, permettant ainsi à la tête de l'appareil de nettoyage de couler au fond de la piscine.
	Les buses de refoulement repoussent le nettoyeur vers la surface ou entre deux eaux.	Rediriger les buses de refoulement afin que la circulation de l'eau n'interfère pas avec le fonctionnement du nettoyeur ou du tuyau.

PROBLÈME	CAUSES	SOLUTION
L'appareil de nettoyage est coincé dans l'échelle, les coins, etc.	Débit d'eau inadéquat	Vérifier le débit de l'eau à l'aide de l'indicateur de débit puis le régler comme indiqué à l'étape 5.
	Semelles usées	Remplacer les semelles
	Ailes usées	Remplacer les ailes
	Le tuyau est trop court	Installer des sections de tuyau supplémentaires en suivant les instructions d'installation.
	Problème de direction	<ol style="list-style-type: none"> 1. Vérifier et nettoyer la grille arrière, si nécessaire 2. Vérifier que l'engrenage du cône est exempt de débris et tourne de manière fluide dans les deux sens 3. Vérifier le programme de direction et la section de dépannage, puis : <ol style="list-style-type: none"> a. nettoyer, réparer ou remplacer la boîte d'engrenages b. vérifier la liaison entre la pièce en A et le patin puis REMPLACER, SI NÉCESSAIRE. NE PAS ESSAYER DE RESSERRER DES PATINS MAL FIXÉS. c. vérifier les ensembles de la turbine moyenne et de l'engrenage de l'axe

GARANTIE

Un programme de garantie limitée protège votre nettoyeur automatique HAYWARD. Pour profiter pleinement de la garantie limitée, veuillez lire, remplir et retourner la carte d'enregistrement dans les 10 jours suivant la date d'achat. Votre carte de garantie se trouve avec le guide d'utilisation et le paquet d'accessoires.

GARANTIE LIMITÉE DE HAYWARD POOL PRODUCTS

Hayward Pool Products garantit aux acheteurs initiaux de cet équipement que ces appareils de nettoyage ne présentent aucun défaut matériel et de fabrication pour une période de DEUX (2) ans à compter de la date d'achat, lorsqu'ils sont utilisés dans des applications résidentielles.

La garantie limitée ne couvre pas les dommages dus au gel, à la négligence, à la mauvaise installation, à un usage ou à un entretien inappropriés ou en cas de force majeure. Les éléments défectueux à cause d'un défaut ou qui deviennent défectueux pendant la période de garantie seront réparés ou remplacés, à notre discrétion, dans les 90 jours après réception du produit défectueux, sauf délai imprévu, sans frais.

Une preuve d'achat sera exigée pour le service de garantie. Dans le cas où aucune preuve d'achat n'est disponible, la date de fabrication du produit sera la seule détermination de la date d'achat.

Pour obtenir le service de garantie, veuillez contacter le lieu d'achat ou le centre de services Hayward agréé le plus proche. Pour trouver le centre de services Hayward agréé le plus près de chez vous, rendez-vous sur notre page www.hayward.com.

Hayward ne sera pas responsable du transport, du retrait, des travaux de réparation ou d'installation ni d'autres frais associés à l'obtention d'un remplacement ou d'une réparation par garantie.

La garantie Hayward Pool Products ne s'applique pas aux composants d'autres fabricants. Pour ces produits, la garantie établie par leur fabricant respectif s'applique.

La garantie expresse limitée ci-dessus constitue l'entière garantie de Hayward Pool Products concernant ses produits pour piscine et se substitue à toute autre garantie explicite ou implicite, y compris les garanties de qualité marchande ou d'adaptation à un emploi particulier. Hayward Pool Products ne sera en aucun cas tenu responsable de quelque dommage indirect, particulier ou accessoire de quelque nature que ce soit.

Certains États n'admettant pas de limitation sur la durée d'une garantie implicite ni l'exclusion des dommages indirects ou accessoires, les limitations susmentionnées ne vous concernent pas nécessairement. Cette garantie vous attribue des droits légaux particuliers et vous pouvez en avoir d'autres, qui varieront d'un État à l'autre.

CARTE D'ENREGISTREMENT

DÉCOUPER ICI : remplir entièrement la partie du bas et l'envoyer par courrier dans les 10 jours qui suivent l'achat ou l'installation ou l'enregistrement en ligne.

CARTE D'ENREGISTREMENT DE LA GARANTIE

Enregistrez-vous en ligne sur www.hayward.com

Veuillez écrire lisiblement :

Prénom _____

Nom _____

Adresse _____

Pays _____

Numéro de téléphone _____

Date de l'achat _____

Adresse courriel _____

Numéro de série _____

Numéro de modèle _____

Capacité de la piscine _____ (gallons américains)

Veuillez m'inclure sur toutes les communications par courriel concernant les équipements ou promotions de Hayward®.

Envoyer par courrier à :
Hayward Pool Products
620 Division Street
Elizabeth, NJ 07201 USA

Attn : Service de garantie

ou ENREGISTRER VOTRE GARANTIE
EN LIGNE SUR WWW.HAYWARD.COM

Merci de votre achat

Nombre d'années de service de la piscine

< 1 an 2-3 4-5 6-10 11-15 >15

Acheté chez :

Constructeur Détaillant Service piscines

Internet/catalogue

Nom de la société _____

Adresse _____

Pays _____

Téléphone _____

Type de piscine :

Béton/gunite Vinyle Fibre de verre

Autre _____

Nouvelle installation Remplacement

Installation pour :

Piscine creusée Piscine hors-sol Spa



Hayward Pool Products
620 Division Street, Elizabeth, NJ 07201 USA
908.351.5400 • www.hayward.com