

NEW WATER® Cyclor Instruction Manual

Chlorine Pool-Care System



Model 400/430 for pools up to 40,000 gallons



Model 120 for pools up to 25,000 gallons



WARNING

To minimize the risk of serious injury, death or damage, before installing or first using this equipment, read Instruction Manual and all safety labels and follow all safety instructions and precautions. Save manual for future reference.

Customer Service 800-222-0169
kingtechnology.com

Ver la versión en español de este manual en kingtechnology.com/brands/new-water

TABLE OF CONTENTS

New Water Introduction	3
Notes and Safety Information	4
Safety Labels on Cyclor	5
Installation Tips to Ensure Proper Performance	6
Filter Flex-Hose Installation Model 120	7
Base Flex-Hose Installation Model 120	8
Hard-Plumbed Installation Model 120	9
In-Line Installation Model 400	10
Off-Line Installation Model 430	11-12
Step 1: Preparing the Pool	13-14
Step 2: Putting the System to Work	15
Step 3: Setting the Control Dial	16
Step 4: Routine Pool Care	17
Winterizing	18
Troubleshooting	19
Parts List Model 120	20
Parts List Models 400/430	21
Maintenance - Replacing Control Dial O-Rings	22
Maintenance - Replacing Cap O-Rings and Knobs	23
Warranty	24

For information on King Technology's entire product line, visit our website at kingtechnology.com

Thank you for choosing New Water. This system will maintain a clean, clear swimming pool while you spend less time on maintenance and more time having fun! There are three models to choose from:

New Water Cycler 400/430



The water treatment center that controls the flow of water to the New Water Cycler Pac. For pools 7,000 to 40,000 gallons. Uses the Cycler Pac Model 407C. (Sold separately).

Model 400 In-Line
Product # 01-01-0400

Model 430 Off-Line
Product # 01-01-0430



Cycler Pac Model 407C
Prefilled with chlorine tablets and fits inside the New Water Cycler Models 400 and 430.

Model 407C
Product # 01-03-4613

New Water Cycler 120



The water treatment center that controls the flow of water to the New Water Cycler Pac. For pools 7,000 to 25,000 gallons. Uses the Cycler Pac Model 105C. (Sold separately).

Model 120 In-Line
Product # 01-01-0120



Cycler Pac Model 105C
Prefilled with chlorine tablets and fits inside the New Water Cycler Model 120.

Model 105C
Product # 01-03-1413

Notes and Safety Information

General Notes

These instructions contain information for the safe and proper operation of this New Water Cyclor. Observe the following principles:

- Ensure that everyone using this New Water Cyclor follows the instructions and safety precautions.
- Keep the instructions nearby and available for reference throughout the service life of this New Water Cyclor.

These instructions do not provide for every possible contingency that might be encountered in connection with installation, operation or maintenance of this equipment. Should further information be desired or should particular issues arise which are not covered sufficiently in this manual, contact King Technology at 800-222-0169.





Explanation of the signal words

Signal words, which depict the probability and severity of harm, are used in these instructions. They are defined as follows:

Signal Word	Meaning
DANGER	Indicates an imminently hazardous situation which, if not avoided, will result in death, serious injury or major property damage.
WARNING	Indicates a hazardous situation which, if not avoided, could result in serious injury, death, or major property damage.
NOTICE	Indicates special instructions that are important but not related to physical injury hazards.

Explanation of the safety pictographs

The following pictographs illustrate the type and source of a hazard.

Pictograph	Type of Danger
	Safety Alert/General Hazard
	Explosion Risk
	Hazardous Pressure
	Flammable Fire Hazard

Identification of warnings

Warnings are intended to help you recognize risks and avoid death, injury or property damage. This is how warnings are identified:

 Signal Word
Pictographs
<p>Description of danger. Consequences if ignored.</p> <p>⇒ The arrow signals a safety precaution to be taken to eliminate or reduce the risk.</p>

Safety Label on Cyclor

Review this label before installing or operating this Cyclor. Contact King Technology at 800-222-0169 if this label is missing from your New Water Cyclor.



Fire, explosion and high pressure hazards

To minimize the risk of serious injury, death or property damage while using the New Water Cyclor:

- ⇒ Read, understand and follow all instructions and safety precautions in the manual, and on this Cyclor and on any label for chemicals used with this Cyclor including New Water Cyclor Pacs.

DANGER

- ⇒ Never use fast dissolving chlorine tablets, liquid bleach, or calcium hypochlorite in the New Water Cyclor.
- ⇒ Never mix Trichlor chlorine tablets with Calcium Hypochlorite, or with any other form of concentrated chlorine or other chemicals.
- ⇒ Never add any other types of chlorine, pH adjusters, shock treatments or algaecides through the skimmer. These products should be added directly into the pool if required.
- ⇒ Do not contaminate the New Water Cyclor or New Water Cyclor Pacs with dirt, organic matter, pool chemicals (such as calcium hypochlorite or pool shocks), fertilizers or other household chemicals. Contact between any of these substances and the New Water Cyclor or New Water Cyclor Pacs, will result in a chemical reaction with the generation of heat, liberation of hazardous gasses and fire or explosion.

WARNING

- ⇒ Use only New Water Cyclor Pacs in the New Water Cyclor. Never use bulk chemicals.
- ⇒ To prevent the build up of gas pressure in the New Water Cyclor, be sure the pool return line valves are open – except when opening or servicing the unit.
- ⇒ Do not inhale fumes from the New Water Cyclor or New Water Cyclor Pacs.
- ⇒ Avoid sparks, smoking, or any open flame near New Water Cyclor or chemicals.
- ⇒ Do not exceed maximum operating pressure of 50 psi or maximum temperature of 104° F.
- ⇒ Do not remove the cap while under pressure. Always turn off pump and bleed off pressure before opening New Water Cyclor.
- ⇒ Do not install automatic or fast shut off valves downstream of New Water Cyclor.
- ⇒ Always install the New Water Cyclor AFTER a heater (if applicable) on the return line.
- ⇒ Always install any additional sanitizing equipment AFTER and NEVER BEFORE the New Water Cyclor is installed on the return line.
- ⇒ Do not permit children to use or climb on this product. This product must be positioned to prevent children from using it as a means of access to the pool.
- ⇒ Always stand clear of the New Water Cyclor during pump start-up.
- ⇒ Replace New Water Cyclor if you see signs of cracks, damage or degradation to the Cyclor body or cap.

NOTICE

- ⇒ Prior to pressurizing, check with your dealer to ensure your plumbing connections meet building codes.
- ⇒ Failure to properly winterize your New Water Cyclor could result in freeze damage. (See page 18 for winterizing details.)

Installation Tips to Ensure Proper Performance

Before installing, read all directions carefully and contact your dealer for installation support.



WARNING

- Do not exceed maximum operating pressure of 50 psi.
- Do not install automatic or fast shut off valves downstream of feeder.
- Always install the New Water Cycler AFTER the heater (if applicable) on the return line.
- Always install any additional sanitizing equipment AFTER and NEVER BEFORE the New Water Cycler is installed on the return line.

1) If using a multi-speed pump, run pump for at least 6 hours per day at high speed (at least 40 gpm).

If the pump will run on low speed 24 hours per day or less than 6 hours per day on high speed, you must bleed the air while the pump is on by unscrewing either the cap knob or back knob until water appears. Then screw the knob back in. Repeat this process each time the cap is removed for any reason.

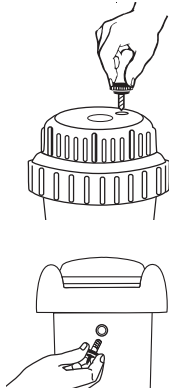

2) Install Cycler with 4-8 psi back pressure.

Lower back pressures could result in under chlorination. Change the eyeball fittings in the return jets to a smaller size to increase back pressure. Contact King Technology at 800-222-0169 for a specially designed Cycler pressure gauge to determine back pressure at pool start-up.

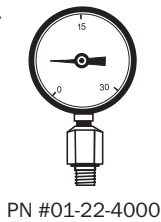

PN #01-22-4000

3) Special Installation Requirements:

IMPORTANT: Over chlorination or damage to the New Water Cycler or other equipment could result if special installations A, B or C are not used in these situations:

- If water flow is higher than 80 gallons per minute (gpm), see diagram A.
- If an in-floor cleaner is included with pool, see diagram B, with two options. Preferred installation is Option 1 with two separate lines.
- If set-up is a pool and spa combination with common equipment, see diagram C.

Questions? Call Customer Service at 800-222-0169 Monday thru Friday, 8 am to 5 pm central standard time.

A. With High Flow Rate (greater than 80 gpm) Install T-fittings exactly as shown.

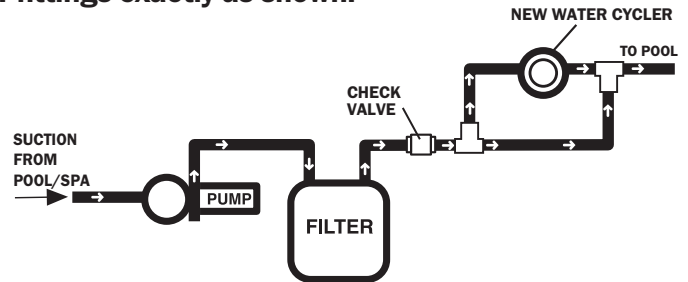

B. With In-Floor Cleaner - TWO OPTIONS

OPTION 1 - A Two-Line Installation

The best option is to have two lines. One line with pump, filter, heater and New Water Cycler and a second line with a separate pump for the in-floor cleaning system (filter optional).

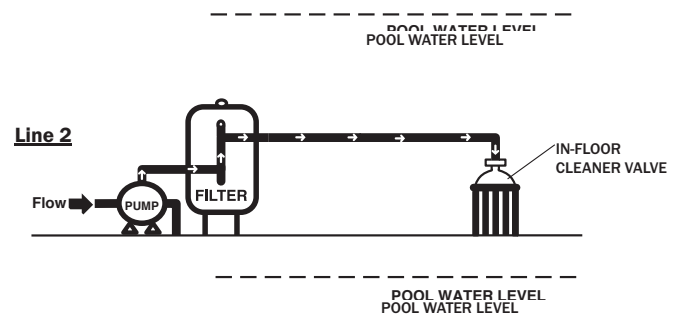
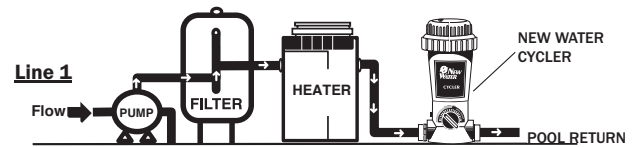

OPTION 2 - A 3-Way Valve Installation

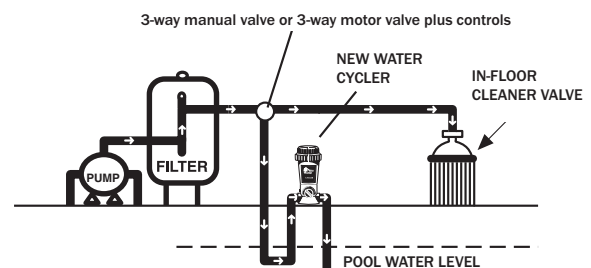

C. Pool and Spill-over Spa Combination

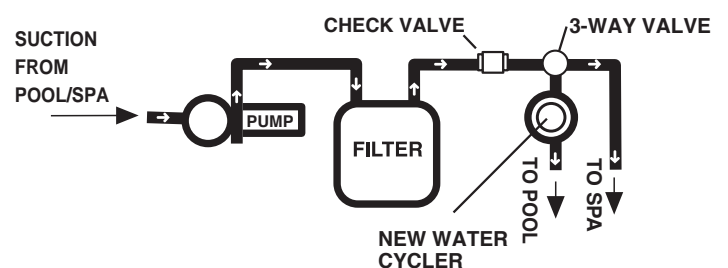

TOOLS NEEDED

Screwdriver



Pipe Wrench

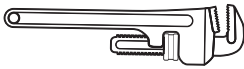

MATERIALS NEEDED

Pipe Thread Tape or Sealant

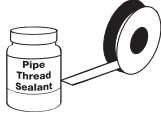

One 6" x 1 1/2" TBE PVC Nipple



One Hose Adapter
1 1/2" x 1 1/2" x 1 1/4"

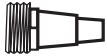

One Section of
1 1/2" or 1 1/4" Flex Hose
(provided with filter)



One
Hose Clamp



RECOMMENDED

4-8 psi Back Pressure

To avoid over or under chlorination, replace eyeball fittings in the return jets to a smaller or larger size to adjust back pressure. For best results use King Technology's pressure gauge, order part number 01-22-4000.



Filter Flex-Hose Installation - Model 120

1.

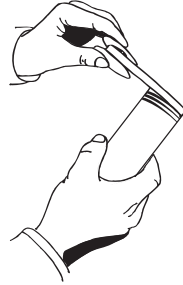

Apply pipe thread tape or sealant to each threaded end of nipple.

2.

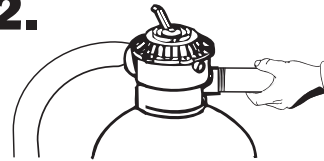

Screw one end of nipple into the filter return.



Hand tighten. Finish tightening by turning 1 to 2 revolutions with a pipe wrench.

DO NOT OVER TIGHTEN.

3.

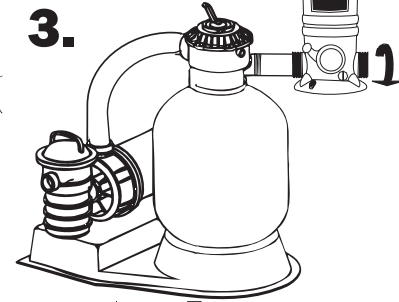

Screw either side of New Water Cycler on to open nipple end until upright and secure.

4.

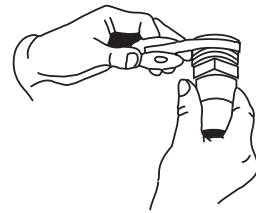

Apply pipe thread tape or sealant to threaded end of hose adapter.

5.

Screw adapter into the other side of New Water Cycler. Hand tighten. Finish tightening by turning 1 to 2 revolutions

with a pipe wrench.

DO NOT OVER TIGHTEN.

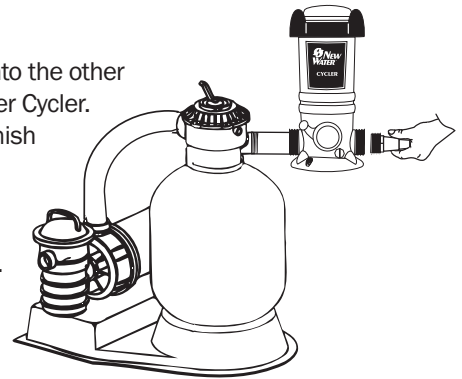
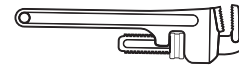

6.

Attach return section of hose to the adapter with clamp. Tighten clamp with screwdriver.

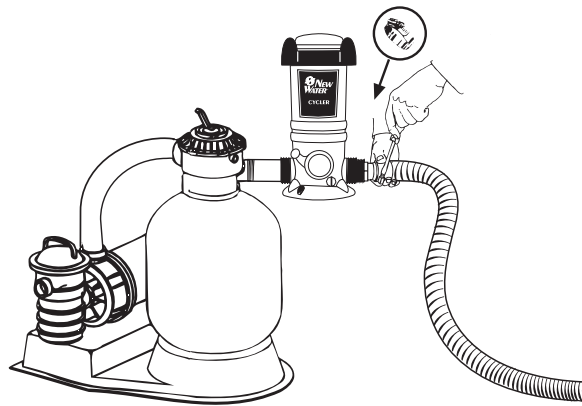

7.

To prevent damage to heaters or filters, see your dealer about installing a **corrosion resistant check valve** which will reduce the back flow of chlorine gas when the New Water Cycler is turned off.

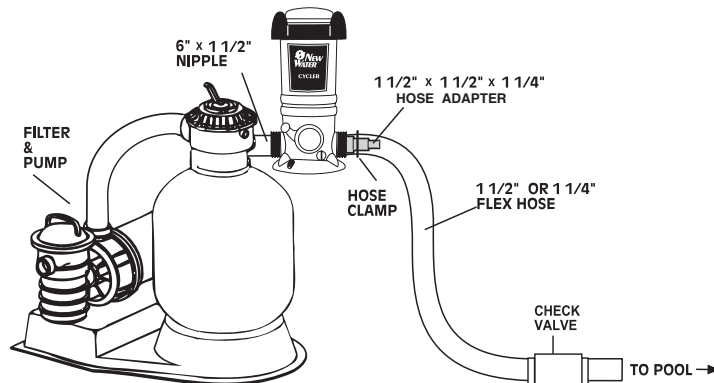

TOOLS NEEDED

Screwdriver



Pipe Wrench

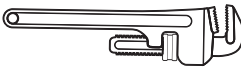

MATERIALS NEEDED

Pipe Thread Tape or Sealant



Two Hose Adapters
1 1/2" X 1 1/2" X 1 1/4"



Two Sections of 1 1/2" or 1 1/4" Flex Hose (one provided with filter)

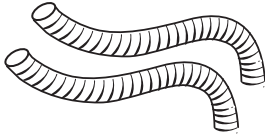

Two Hose Clamps



RECOMMENDED

4-8 psi Back Pressure

To avoid over or under chlorination, replace eyeball fittings in the return jets to a smaller or larger size to adjust back pressure. For best results use King Technology's pressure gauge, order part number 01-22-4000.



Base Flex-Hose Installation - Model 120

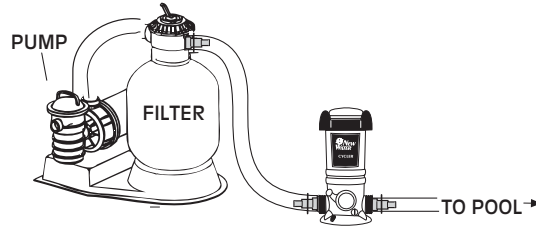

The New Water Cycler should always be installed between the filter and pool (or between heater and pool if applicable). Never install New Water Cycler before the heater or damage to the heater could occur.

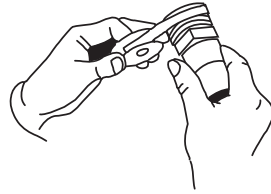

1. Apply pipe thread tape or sealant to the threaded end of both hose adapters.

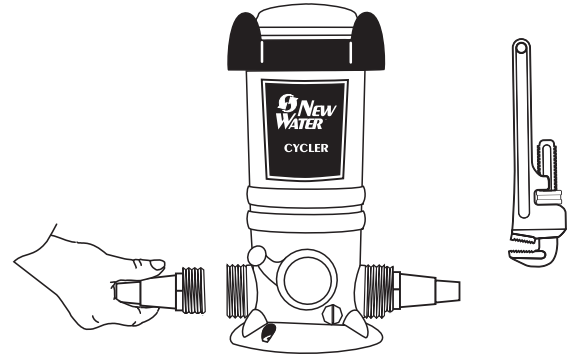

2. Screw adapters into each end of New Water Cycler. Hand tighten. Finish tightening by turning 1 to 2 revolutions with a pipe wrench. **DO NOT OVER TIGHTEN.**

3. Attach the filter section of flex hose to one hose adapter and the return section of flex hose to the other hose adapter with clamps and tighten with screwdriver. Bi-flow valve design allows installation in either flow direction.

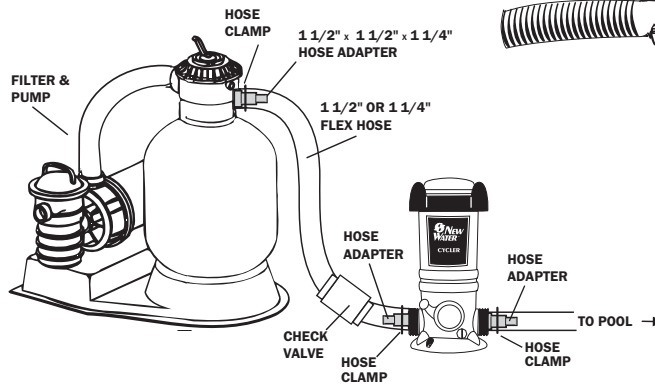
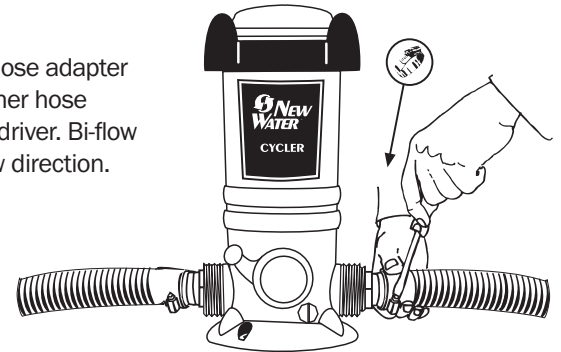

4. To prevent damage to heaters or filters, see your dealer about installing a **corrosion resistant check valve** which will reduce the back flow of chlorine gas when the Cycler is turned off.

5. For better stability, New Water Cycler may be mounted on a treated wood base using **Phillips pan head screws**, one in front and two in back. If you have questions about stability, please contact your dealer or King Technology.

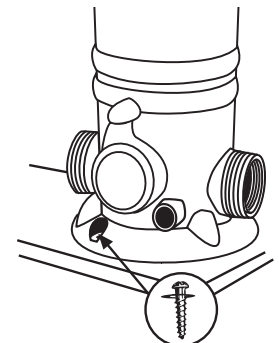

TOOLS NEEDED

Pipe Wrench

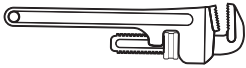

Hacksaw



Tape Measure

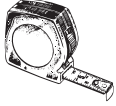

MATERIALS NEEDED

Pipe Thread Tape or Sealant, Primer and PVC Cement

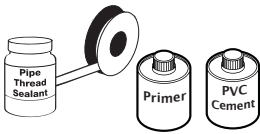

1½" Male Adapter (slip x MPT)



or

2" Female Adapter (slip x FPT)



SECURE CYCLER

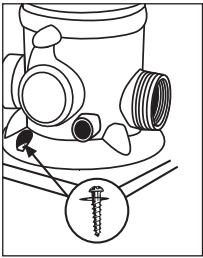

For better stability, New Water Cycler may be mounted on a treated wood base using **Phillips pan head screws**, one in front and two in back. If you have questions about stability, please contact your dealer or King Technology.

Hard-Plumbed Installation - Model 120

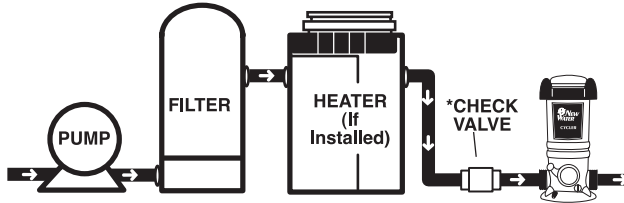

The New Water Cycler should always be installed between the filter and pool (or between heater and pool if applicable). Never install New Water Cycler before the heater or damage to the heater could occur.

Do NOT install in copper pipe as chemical corrosion may lead to pipe failure.



Do NOT install New Water Cycler Model 120 off-line.

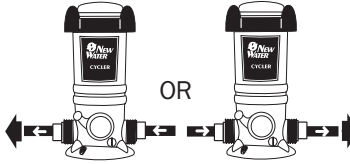

Bi-flow valve design allows installation in either flow direction.

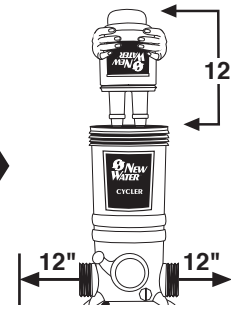

Allow a minimum of 12" above and on each side of New Water Cycler to ensure room for easy replacement of New Water Cycler Pac.

1. Screw adapters into each end of New Water Cycler following directions for a male adapter or a female adapter. Hand tighten. Finish tightening by turning 1 to 2 revolutions with a pipe wrench. **DO NOT OVER TIGHTEN.**

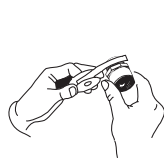

1a.

If using **male adapters**, apply pipe thread tape or sealant to the threaded end of each adapter.



1b.

If using **female adapters**, apply pipe thread tape or sealant to the threaded end of each feeder port.

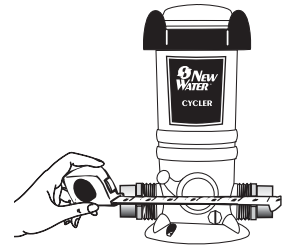
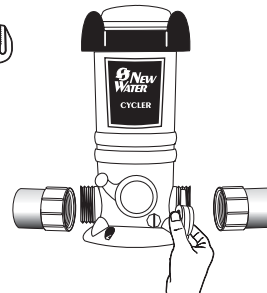

2. Measure the distance between the outside adapters and cut out a section of pipe 3" less than that dimension.

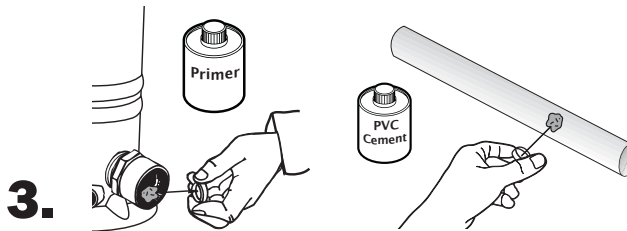

3.

Following primer directions, brush primer on the inside of the adapters and to ends of pipe. Repeat this process with PVC cement following directions on that product.

4.

Insert PVC pipe into adapters with a twisting action. Hold in place 5 to 10 seconds to bond.

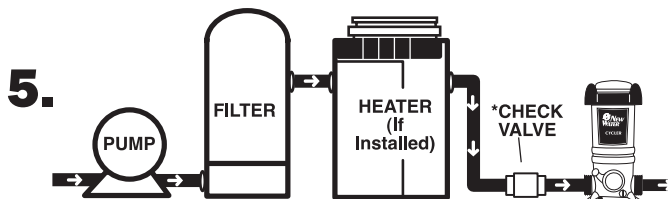
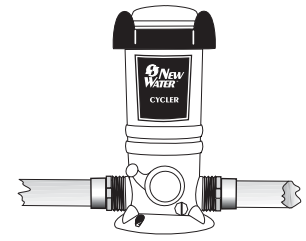

5.

To prevent damage to heaters or filters, see your dealer about installing a **corrosion resistant check valve** which will reduce the back flow of chlorine gas when the Cycler is turned off.

TOOLS NEEDED

Pipe Wrench

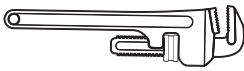

Hacksaw

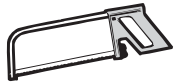

Tape Measure

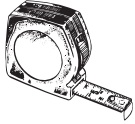

MATERIALS NEEDED

Pipe Thread Sealant



Primer and PVC Cement

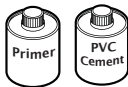

Two 2" Threaded x 2" or 1½" Slip male adapters (not Included)



SECURE CYCLER

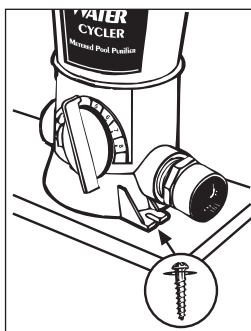

For better stability, New Water Cyclor may be mounted on a treated wood base using **Phillips pan head screws**, one in front and one in back. If you have questions about stability, please contact your dealer or King Technology.

In-line Installation - Model 400

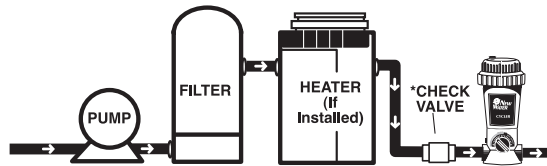

The New Water Cyclor should always be installed between the filter and pool (or between heater and pool if applicable). Never install New Water Cyclor before the heater or damage to the heater could occur.

Do NOT install in copper pipe as chemical corrosion may lead to pipe failure.

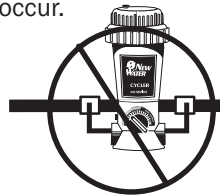

Do NOT install New Water Cyclor Model 400 off-line.



Bi-flow valve design allows installation in either flow direction.

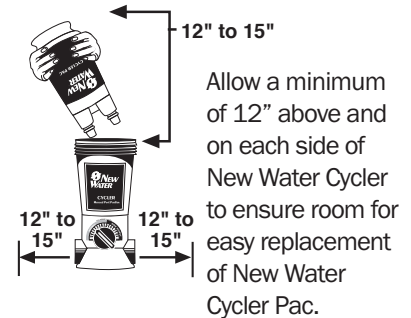

Allow a minimum of 12" above and on each side of New Water Cyclor to ensure room for easy replacement of New Water Cyclor Pac.

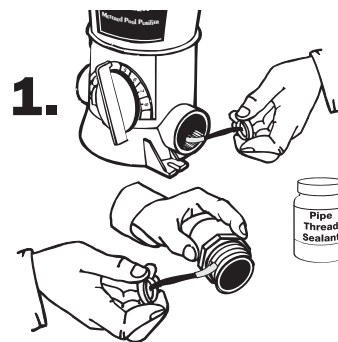

Following pipe thread sealant directions, brush sealant onto New Water Cyclor threads in both ports and both male adapters.

DO NOT USE PIPE THREAD TAPE

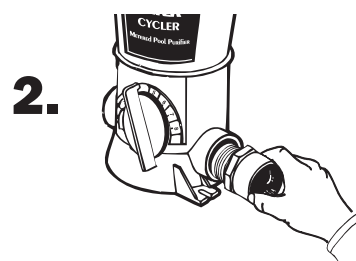

Screw a male adapter into each port of New Water Cyclor. Hand tighten. Finish tightening by turning 1 to 2 revolutions with a pipe wrench.

DO NOT OVER TIGHTEN.

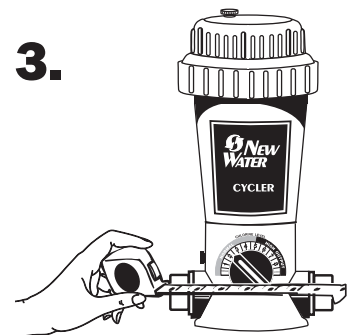
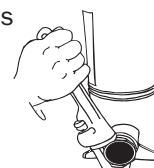

Measure the distance between New Water Cyclor male adapters and cut out a section of pipe 3" less than that dimension.

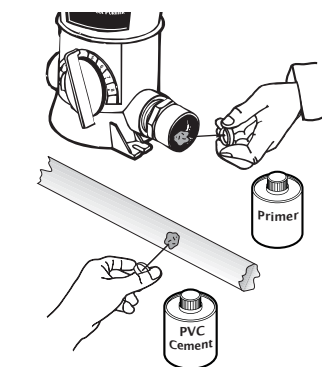

Following primer directions, brush primer on the inside of the male adapters and to ends of pipe. Repeat this process with PVC cement following manufacturer's directions on that product.

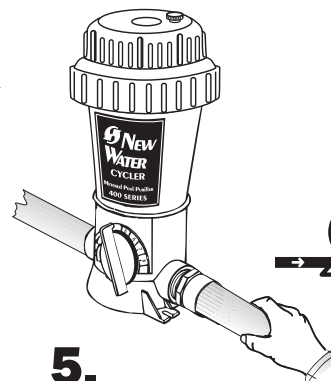

Insert PVC pipe into male adapters with a twisting action. Hold in place 5 to 10 seconds to bond.

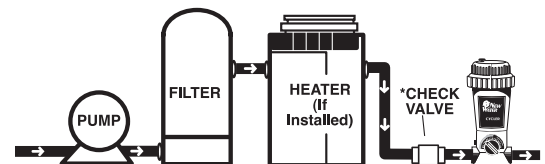

To prevent damage to heaters or filters, see your dealer about installing a **corrosion resistant check valve** which will reduce the back flow of chlorine gas when the Cyclor is turned off.

TOOLS NEEDED

Screwdriver



Pipe Wrench

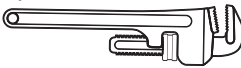

Battery

Operated Drill
with 5/8" or 19/32"
Bit

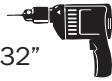

MATERIALS NEEDED

Pipe Thread
Sealant



Primer and
PVC Cement

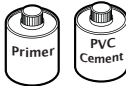

OFF-LINE KIT

Included with the
New Water Cycler

Two Male
Adapters



Two Reducer
Bushings



Two 90
Degree Elbows



Four Hose
Clamps



6' of Tubing



Two
Scoops



Two Scoop
Gaskets



Two Scoop Clamps

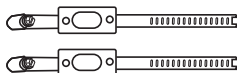

Off-line Installation - Model 430

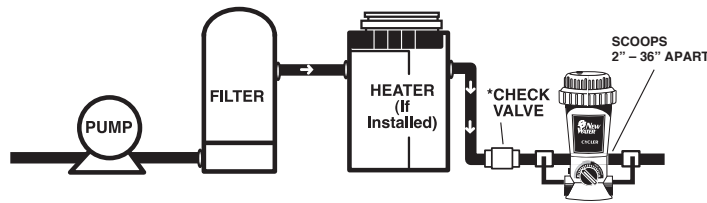

The New Water Cycler should always be installed between the filter and pool (or between heater and pool if applicable). Never install New Water Cycler before the heater or damage to the heater could occur.

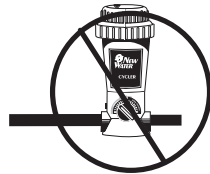

Do NOT install New Water Cycler Model 430 in-line as this Cycler is different than an in-line unit.

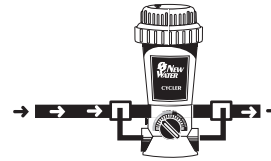

OR

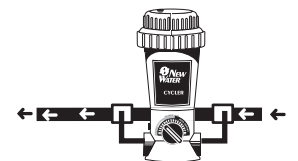

Bi-flow valve design allows installation in either flow direction.

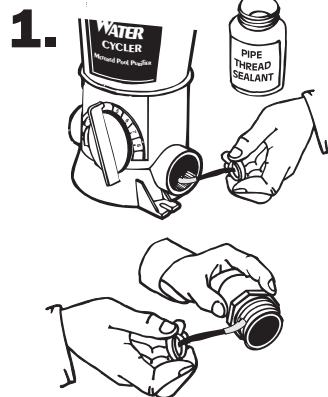

1. Following pipe thread sealant directions, brush sealant onto New Water Cycler threads in both ports and on both male adapters.

DO NOT USE PIPE THREAD TAPE as the threads on these units are not suitable for this use and leaking or fitting failure could result.

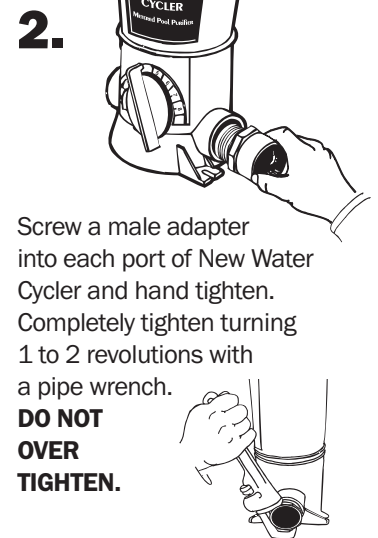

2. Screw a male adapter into each port of New Water Cycler and hand tighten. Completely tighten turning 1 to 2 revolutions with a pipe wrench.

DO NOT OVER TIGHTEN.

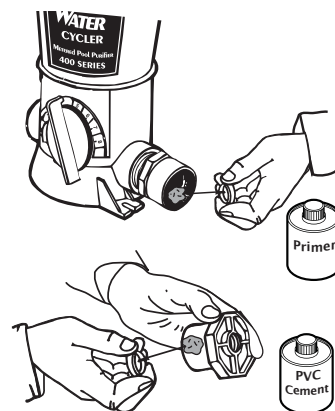
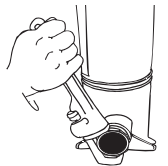

3. Following Primer directions, brush Primer on reducer bushings and inside of male adapters. Repeat this process with PVC cement following manufacturer's directions on that product.

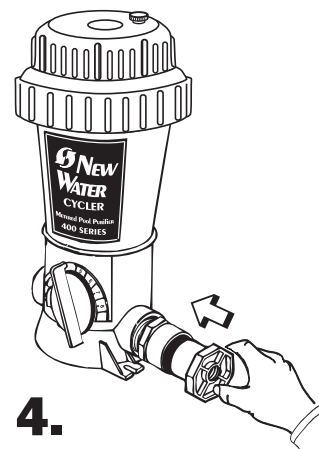

4. Insert reducer bushing into male adapter on both sides with a twisting action. Hold in place 5 to 10 seconds to bond.

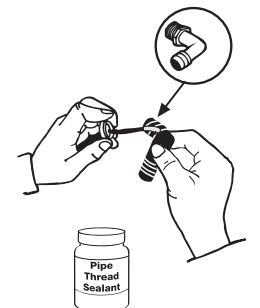

5. Following pipe thread sealant directions, brush sealant onto elbow threads.

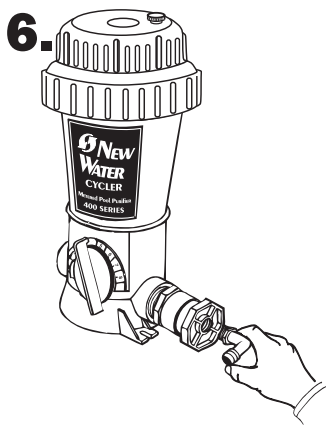

Screw elbow into reducer bushings on both sides.

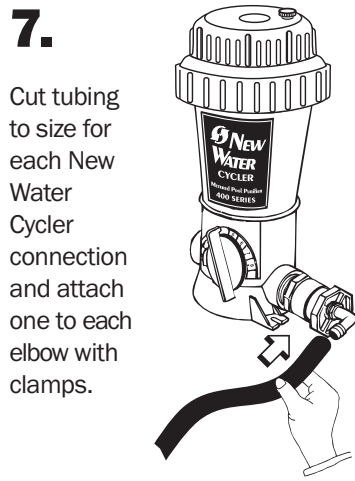

Cut tubing to size for each New Water Cyclor connection and attach one to each elbow with clamps.



Tighten clamps with a screwdriver.

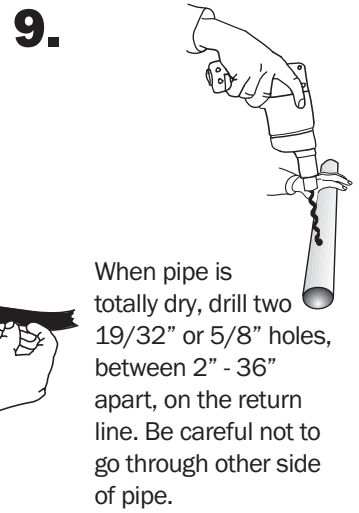

When pipe is totally dry, drill two 19/32" or 5/8" holes, between 2" - 36" apart, on the return line. Be careful not to go through other side of pipe.

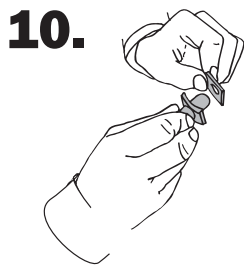

Attach a gasket to each scoop.

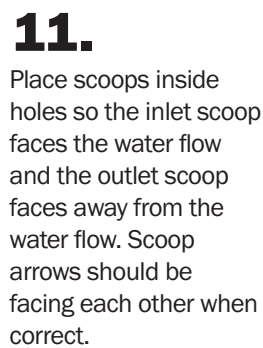

Place scoops inside holes so the inlet scoop faces the water flow and the outlet scoop faces away from the water flow. Scoop arrows should be facing each other when correct.

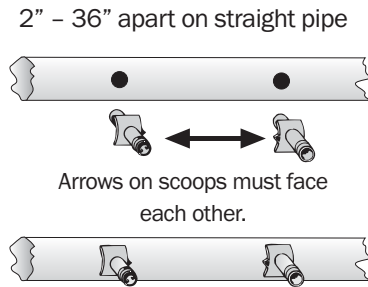

2" - 36" apart on straight pipe

Arrows on scoops must face each other.

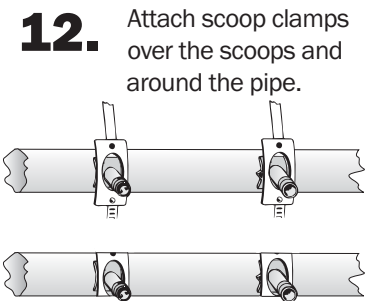

Attach scoop clamps over the scoops and around the pipe.



Tighten scoop clamps with a screwdriver.

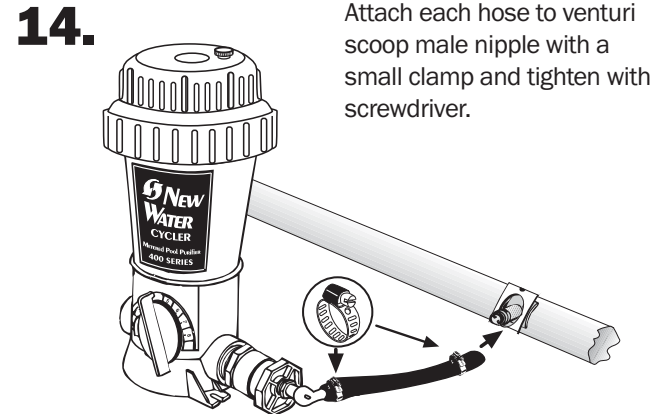

Attach each hose to venturi scoop male nipple with a small clamp and tighten with screwdriver.

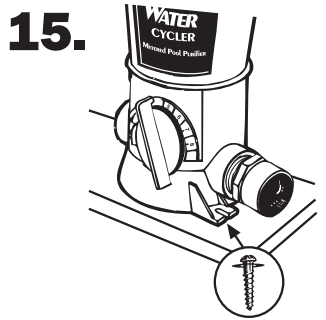

For better stability, New Water Cyclor may be mounted on a treated wood base using **Phillips pan head screws**, one in front and one in back. If you have questions about stability, please contact your dealer or King Technology.

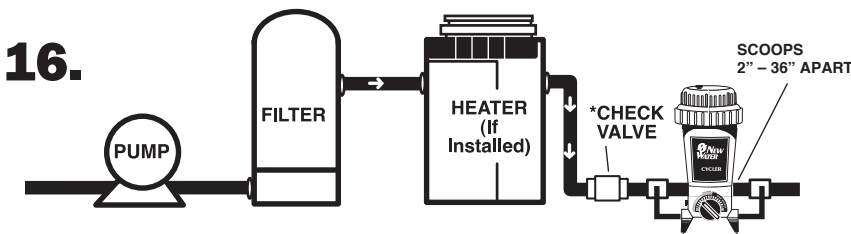

To prevent damage to heaters or filters, see your dealer about installing a **corrosion resistant check valve** which will reduce the back flow of chlorine gas when the Cyclor is turned off.

Step 1: Preparing the Pool

1.



Make sure the pool has adequate circulation. The total volume of pool water must completely circulate through the pump and filter at least 1 to 2 times per day. This usually requires 8 to 12 hours of circulation. Check with your dealer for the proper circulation time for your pool.

2.

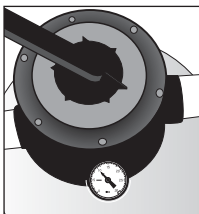

Check the pool's filter gauge often and periodically clean filter per the manufacturer's directions. A dirty filter will slow the flow of water which could hamper proper circulation.



WARNING

Do not exceed maximum operating pressure of 50 psi.

3.

Check the Water Hardness of your fill water before adding to the pool. If calcium content is higher than 400 ppm, find a soft water source to fill your pool instead; otherwise water balance will be very difficult.

4.



Check for metals in the pool such as iron or copper. Before attempting water balance, these should be removed. See your dealer for a metal out or sequesterant and follow the label directions carefully.

5.

Before beginning with any pool care program, you must first balance your pool water. Take a water sample to your local pool professional (or use a complete test kit) to test for the important Water Balance Guidelines.

IMPORTANT: Always follow printed instructions on the balancing chemical packages. Add balancing chemicals in small increments one at a time with circulation running. **For best results, wait 8-12 hours** before testing again and adding any additional balancing chemicals.

Water Balance Guidelines

pH:	7.2 – 7.8
Total Alkalinity:	80 – 120 ppm
Calcium Hardness:	200 – 400
Total Dissolved Solids:	<1500
Stabilizer:	20 – 80 ppm
Free Chlorine:	1.0 – 3.0 ppm

Continue...Step 1: Preparing the Pool - Page 14

Continue... Step 1: Preparing the Pool

For best results in achieving water balance, follow steps **5a through 5e** in order.

5a. Take a water sample from the pool and dip a Test Strip into it.

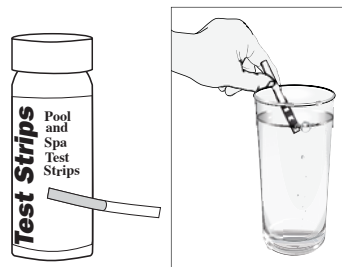

5b. Look at the **Total Alkalinity** reading first. Adjustments should be made to bring the Total Alkalinity in the range of **80 – 120 ppm** prior to making any adjustments to pH even if it throws pH off further.

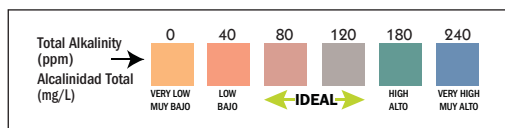

5c. After Total Alkalinity is in range, test for **pH**. It should be between **7.2 and 7.8**. If higher or lower, add a pH adjuster.

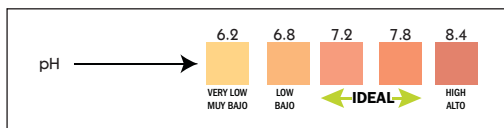

5d. Then test your Water Hardness again. If lower than 200 ppm, add Calcium Increaser. Always maintain 200-400 ppm.

5e. Lastly, test for **stabilizer** or **conditioner levels**. Add conditioner if the level is below 20 ppm. This will prevent chlorine burn off. If stabilizer level is above 80 ppm, partially drain water and re-fill.

6. Initially shock the pool with **chlorine shock only** to rid the water of contaminants and establish a chlorine residual. Always follow the manufacturer's directions carefully. See the DANGER box below for important guidance on shocking.



DANGER

- Never add any other types of chlorine, pH adjusters, shock treatments or algaecides through the skimmer. These products should be added directly into the pool if required.
- Never use fast dissolving chlorine tablets, liquid bleach, or calcium hypochlorite in the New Water Cyclor.

Step 2: Putting the System to Work



DANGER

Never use fast dissolving chlorine tablets, liquid bleach, or calcium hypochlorite in the New Water Cycler.



WARNING

Avoid sparks, smoking, or any open flame near New Water Cycler or chemicals.

IMPORTANT: Read the label on the New Water Cycler Pac carefully before using.

1.

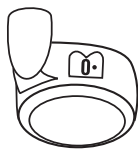

Model 120



Model 400/430

Turn off pump. Turn dial to 0 or Minimum. This reduces the flow of water into the unit when the cap is open.

2.



Model 120

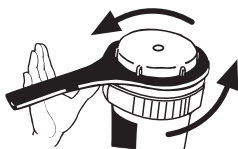

Model 400/430

Open the cap. For Model 400/430 pools use the cap tool included with New Water Cycler to loosen cap by hitting the handle with the flat of your hand counterclockwise. Stand back to allow any chlorine fumes to dissipate.

3.

Cut handle from New Water Cycler Pac using a PVC cutting tool (KEEP OUT OF REACH OF CHILDREN)

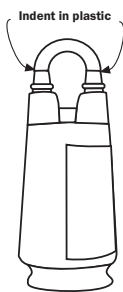

3A. Find the indent in the plastic.



3C. Squeeze the handles together. Repeat for other side.



PVC cutting tool available at local hardware stores.

3B. Place curved section of tool around the narrow end of one pac tower and line up blade on indent

Finished cut ends

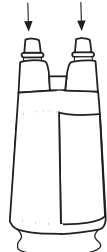

3D. Make sure the blade comes straight across on the indent line for a clean cut.

3E. If openings are pinched together, open with fingers or re-cut closer to the colored screens inside New Water Cycler Pac. Leave at least 1/4" of plastic to fit into New Water Cycler base.

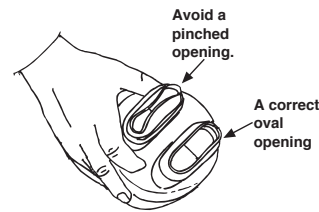

4.

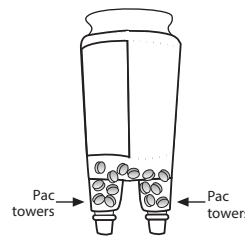

Invert New Water Cycler Pac and shake slightly until chlorine tablets fall into tower areas.

5.

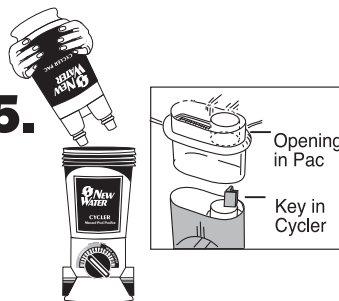

Insert New Water Cycler Pac into New Water Cycler, lining up the openings in New Water Cycler Pac with keys in New Water Cycler.

NOTE: Openings are a different shape than keys.

6.

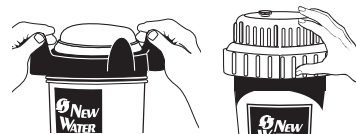

Model 120

Model 400/430

Replace cap by hand only. **DO NOT OVERTIGHTEN.**



DO NOT USE CAP TOOL TO TIGHTEN CAP. FOR REMOVAL ONLY.

7.



The New Water Cycler Pacs are made of HDPE plastic. Non-refillable container. Do not reuse or refill this container. Offer for recycling if available. Rinse thoroughly before recycling or discarding in trash.

8.



Mark your calendar ahead for the approximate replacement times for the New Water Cycler Pac.

Step 3: Setting Control Dial

1. This system is designed to work effectively with a variety of pool equipment as long as the following procedures are followed.

Set control dial on New Water Cycler by matching up the parameters of your pool on the chart below. THIS IS A STARTING POINT ONLY and may need to be adjusted to fit your individual pool needs. See #2 below for adjusting directions.

IMPORTANT: If using a multi-speed pump, pump-run times of at least 6 hours per day at high speed are recommended for proper performance. **If running the pump at low speed only or on high speed less than 6 hours, please follow the 24 hour low-speed directions below.**

MODEL 120 POOL SIZE Gallons Diameter	8 HOUR PUMP RUN TIME				12 HOUR PUMP RUN TIME				24 HOUR PUMP RUN TIME			
	PUMP SIZE				PUMP SIZE				PUMP SIZE			
	1/2 hp	3/4 hp	1 hp	1 1/2 hp	1/2 hp	3/4 hp	1 hp	1 1/2 hp	1/2 hp	3/4 hp	1 hp	1 1/2 hp
7,000 (18')	4.5	4.0	3.5	3.0	2.5	2.0	1.0	3.0^	1.5	1.0	1.0	2.0^
9,000 (21')	5.0	4.5	4.0	3.5	3.0	2.5	2.0	3.5^	2.0	1.5	1.0	2.5^
12,000 (24')	5.5	5.0	4.5	4.0	3.5	3.0	2.5	2.0	2.5	2.0	1.5	3.0^
18,000	NR	5.5	5.0	4.5	4.0	3.5	3.0	2.5	3.0	2.5	2.0	1.5
20,000	NR	NR	5.5	5.0	4.5	4.0	3.5	3.0	3.5	3.0	2.5	2.0
25,000	NR	NR	6.0	5.5	5.0	4.5	4.0	3.5	4.0	3.5	3.0	2.5

MODEL 400 POOL SIZE Gallons	SINGLE-SPEED PUMP OR HIGH-SPEED PUMP RUN TIME											
	6 HOUR PUMP RUN TIME				12 HOUR PUMP RUN TIME				24 HOUR PUMP RUN TIME			
	PUMP SIZE				PUMP SIZE				PUMP SIZE			
	3/4 hp	1 hp	1 1/2 hp	2 hp	3/4 hp	1 hp	1 1/2 hp	2 hp	3/4 hp	1 hp	1 1/2 hp	2 hp
7,000	3.5	3.0	2.5	2.5^	2.5	2.0	3.5^	3.0^	1.0	3.0^	2.5^	2.0^
9,000	4.0	3.5	3.0	2.5	3.0	2.5	2.0	3.5^	2.0	3.5^	3.0^	2.5^
12,000	4.5	4.0	3.5	3.0	3.5	3.0	2.5	2.0	2.5	2.0	1.0	3.0^
18,000	NR	4.5	4.0	3.5	4.5	3.5	3.0	2.5	3.0	2.5	2.0	1.5
25,000	NR	NR	4.5	3.5	NR	4.5	3.5	3.0	3.5	3.0	2.5	2.0
30,000	NR	NR	5.5	4.5	NR	5.0	4.5	3.5	NR	3.5	3.0	2.5

^Bypass installation recommended. See "Installation Tips" on page 6 **NR**- This pump size is not recommended for this size pool.

24 HOUR, LOW-SPEED PUMP RUN TIME

In order to ensure proper performance when running the pump on low speed for 24 hours per day or high speed less than 6 hours per day, bleed the air while the pump is on by unscrewing the cap or back knob until water appears. Then screw the knob back in. Repeat this process each time the cap is removed for any reason. Set the control dial at 6 and follow the adjustment directions in Step 2 to determine the correct setting for your pool.

EXAMPLE

MODEL 400 POOL SIZE Gallons	12 HOUR PUMP RUN TIME			
	PUMP SIZE			
	3/4 hp	1 hp	1 1/2 hp	2 hp
7,000	2.5	2.0	3.5^	3.0^
9,000	3.0	2.5	2.0	3.5^
12,000	3.5	3.0	2.5	2.0
18,000	4.5	3.5	3.0	2.5
25,000	NR	4.5	3.5	3.0
30,000	NR	5.0	4.5	3.5

Find your starting dial setting by matching up the parameters of your pool on the above chart. An above ground pool with approximately 12,000 gallons, with a 1 1/2 horsepower pump running 12 hours a day, would require a starting setting of 2.5.

2.



For the first week, test the pool water daily for free chlorine to ensure correct dial setting. Continue to test weekly throughout the season.



After each testing, adjust the dial up by 1/2 increment if the free chlorine reading has dropped or down by 1/2 increment if the reading has risen. Continue this process each day until the reading stabilizes at your desired level between 1.0- 3.0 ppm. Remember to adjust dial by 1/2 increments only.

IMPORTANT: Control dial settings in excess of these recommendations could result in excess trichlor levels being discharged into the pool. This can result in bleaching or discoloration of areas around the pool inlet or in some cases bleaching or discoloration of the entire pool liner or paint. In addition, excess trichlor in the pool can create health hazards to bathers.



Use the handle end of cap tool if the dial is hard to turn.

Step 4: Routine Pool Care

1.



Run filtration system enough hours to circulate all water 1 to 2 times per day. More than that could result in over chlorination.



WARNING

To prevent the build up of gas pressure in the New Water System, be sure the pool return line valves are open except when opening or servicing the unit.

2.



Regularly test water with to maintain pH and Total Alkalinity.

NOTE: Water balance is affected by bather load, chemical usage, evaporation and the makeup of source water, so maintaining water balance regularly is important.

3.



Maintain 1.0 - 3.0 ppm free chlorine level at all times.



DANGER

Do not contaminate the New Water Cycler or New Water Cycler Pacs with dirt, organic matter, pool chemicals (such as calcium hypochlorite or pool shocks), fertilizers or other household chemicals. Contact between any of these substances and the New Water Cycler or New Water Cycler Pacs will result in a chemical reaction with the generation of heat, liberation of hazardous gasses and fire or explosion.

4.

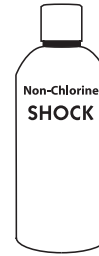

Shock the pool every week or as needed with a non-chlorine or chlorine shock.



DANGER

- Never add any other types of chlorine, pH adjusters, shock treatments or algaecides through the skimmer. These products should be added directly into the pool if required.
- Never use fast dissolving chlorine tablets, liquid bleach, or calcium hypochlorite in the New Water Cycler.

Winterizing (Model 120 or Model 400/430)

1. Turn pump off.

Turn dial to 0 OR Turn dial to minimum

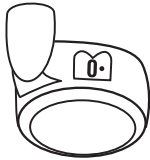

Model 120

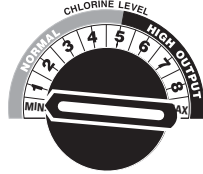

Model 400/430

2. Remove cap.



Model 120

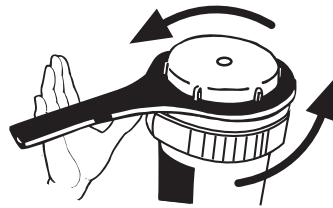

Model 400/430

3. Unscrew knob from New Water Cycler. Allow all water to drain.



Model 120

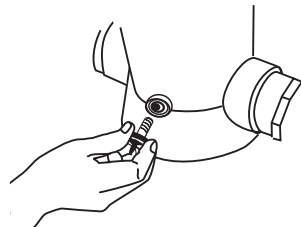

Model 400/430

4. Remove Pac.



Model 120



Model 400/430



If New Water Cycler Pac still contains chlorine, wrap in plastic bag and store in shed or cool, dry, well-ventilated location away from children, pets, cars, motorcycles or anything metal that can rust, pit, etc.

If empty, rinse and recycle.



WARNING

Avoid sparks, smoking, or any open flame near New Water Cycler or chemicals.

5. Replace the cap and knobs loosely.



Model 120



Model 400/430

Troubleshooting

For help in troubleshooting, call King Technology at 800-222-0169.

Problem	Remedy		
<p>1. What do I do if the water looks cloudy?</p>	<p>1. Make sure your filtration system is working properly (i.e. clean filter, skimmer and pump basket).</p> <p>2. Make sure circulation time is adequate – increase pump time if not.</p>	<p>3. Make sure the pool is properly balanced (see page 13).</p> <p>4. Shock the water to eliminate build up of any organic matter.</p>	<p>5. Make sure pool has a free chlorine reading of 1.0 to 3.0 ppm.</p> <p>6. Check with your dealer for more information.</p>
<p>2. What do I do if the water turns color?</p>	<p>1. Algae may be trying to form – shock the pool, increase circulation time if needed and clean the filter.</p>	<p>2. Metals in the fill water may have been oxidized. Have the pool tested. See pool dealer if a metal control product is required.</p>	<p>3. Check with your dealer for more information.</p>
<p>3. What do I do if algae forms in or on my pool?</p>	<p>1. Use an algaecide per the directions on the bottle and brush the sides of the pool often.</p>	<p>2. Clean the filter and shock the pool with chlorine daily until water clarity returns</p>	<p>3. Check with your dealer for more information.</p>
<p>4. What do I do if I am under chlorinating with the New Water Cycler Pac?</p>	<p>1. If you are unable to maintain at least 1.0 ppm, first make sure there are chlorine tablets in the tower areas of the New Water Cycler Pac and it is installed properly. If a correction was made, test the water in 24 hours.</p> <p>2. If still low, turn the dial up one setting and test the water again in 24 hours. Continue raising the setting by one increment each day until the proper reading is achieved.</p>	<p>3. Shock the pool if the reading has been lower than 1.0 ppm for more than one day.</p> <p>4. Make sure pump run time is at least 6 hours on high speed (40 gpm or higher) or if not, bleed the air from the cap or back knob each time cap is open.</p> <p>5. Contact your dealer to have your back pressure tested. If under 4 psi consider a smaller eye-ball fitting in the return jet.</p>	<p>6. Check for a suction side leak by looking for air bubbles in your pump basket or at the return jet. Contact dealer for help in correcting this situation.</p> <p>7. Contact King Technology's Customer Service Department at 800-222-0169.</p>
<p>5. What do I do if I am over chlorinating with the New Water Cycler Pac?</p>	<p>1. If the chlorine reading is over 3.0 ppm, remove the New Water Cycler Pac from the New Water Cycler and test the water daily until the reading is down to 1.0 ppm.</p> <p>2. Reinsert the New Water Cycler Pac, lower the dial one setting and test the water again in 24 hours. If the reading has risen, lower the dial one setting again. Continue this process until proper reading is achieved.</p>	<p>3. If over-chlorinating at the lowest possible setting, consider decreasing the circulation time. Depending on your pump size, you may be circulating the water more than is necessary.</p> <p>4. Contact your dealer to have your back pressure tested. If over 8 psi consider a larger eye-ball fitting in the return jet.</p>	<p>5. Check to see if the pressure relief valve is loose or missing and replace. It is a clear plastic piece approximately 1" long installed inside near the base. If loose or missing, it can provide another avenue for water to reach the chlorine.</p> <p>6. Contact King Technology's Customer Service Department at 800-222-0169.</p>

Parts List • Model 120

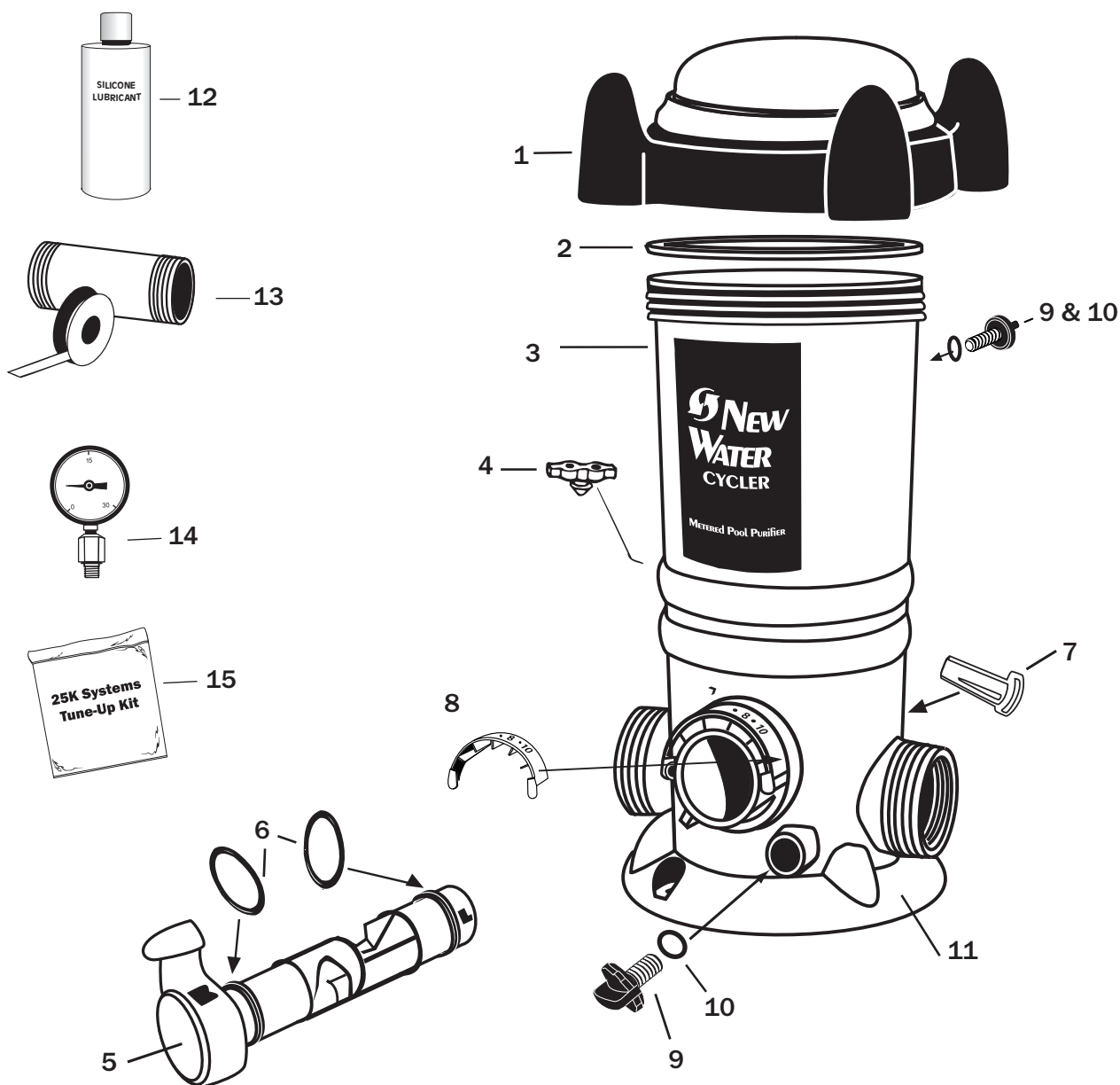

Included with New Water 120

REF. #	DESCRIPTION	QTY. INCLUDED
1 & 2	Cap w/O-Ring	1
3	Body	1
4	Pressure Relief Valve	1
5, 6, 7, 8	Control Dial with O-Rings, Locking Pin and Number Plate	1
9 & 10	Knob with O-Ring	2
11	Mounting Base	1
12	Silicone Lubricant	1

Replacement Parts for New Water 120

REF. #	PART NO.	DESCRIPTION
1 & 2	01-22-1410	Cap w/O-Ring
2	01-22-1926	Cap O-Ring
4	01-22-9486	Pressure Relief Valve
5, 6, 7, 8	01-22-1446	Control Dial with O-Rings Locking Pin and Number Plate
6	01-22-1456	Control Dial O-Ring Set
9 & 10	01-22-9946	Knob with O-Ring
11	01-22-1485	Mounting Base
12	01-22-9970	Silicone Lubricant
13	01-22-1710	Nipple Kit
14	01-22-4000	Pressure Gauge
15	01-22-1470	25k Tune-Up Kit

Parts List • Models 400 and 430

INCLUDED WITH • Model 400 and 430

REF. #	DESCRIPTION	QTY. INCLUDED
1 & 2	Cap w/O-Ring	1
3	Body	1
4	Pressure Relief Valve	1
5, 6, 7	Control Dial with O-Rings	1
8 & 9	Knob with O-Ring	2
18	Cap/Control Dial Tool	1
19	Silicone Lubricant	1

REPLACEMENT PARTS • Model 400 and 430

REF. #	PART NUMBER	DESCRIPTION
1 & 2	01-22-9418	Cap w/O-Ring
2	01-22-9926	Cap O-Ring
4	01-22-9486	Pressure Relief Valve
5, 6, 7	01-22-9446	Control Dial with O-Rings
6 & 7	01-22-9456	Control Dial O-Ring Kit
8 & 9	01-22-9946	Knob with O-Ring
18	01-22-8870	Cap/Control Dial Tool
19	01-22-9970	Silicone Lubricant
20	01-22-4000	Pressure Gauge
21	01-22-9950	40k Tune-Up Kit

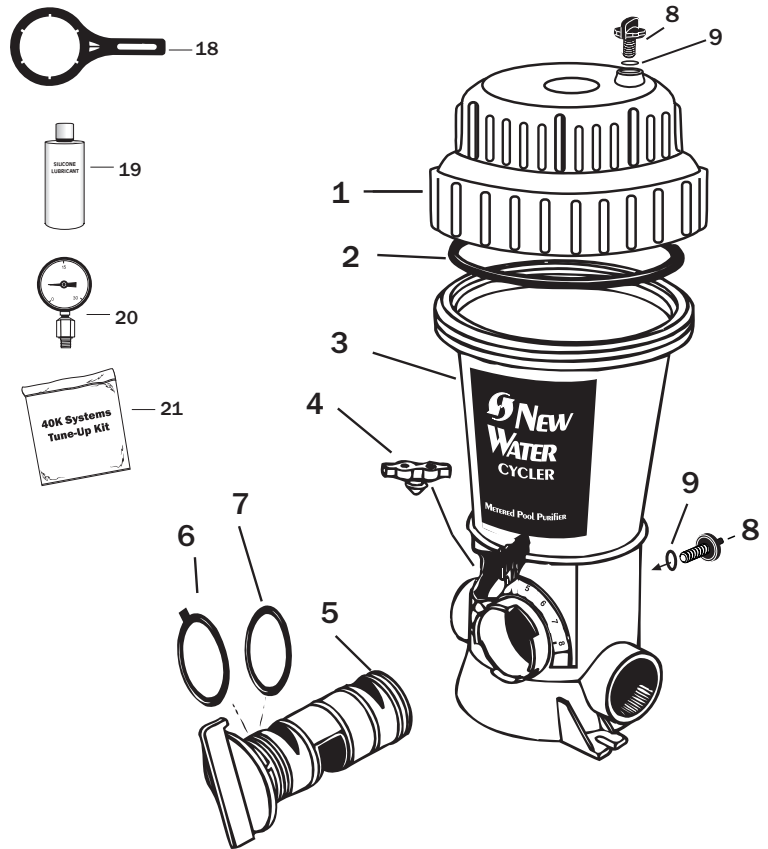

1100151001

Off-line installation parts included with model 430

INCLUDED WITH OFF-LINE Model 430

REF. #	DESCRIPTION	QTY. INCLUDED
10	2" Male Adapter	2
11	2" X 1/2" Bushing	2
12	90 Degree Elbow	2
13	Small Clamp	4
14	6' PVC Tubing	1
15	Scoop Gasket	2
16	Venturi Scoop	2
17	Scoop Clamp	2

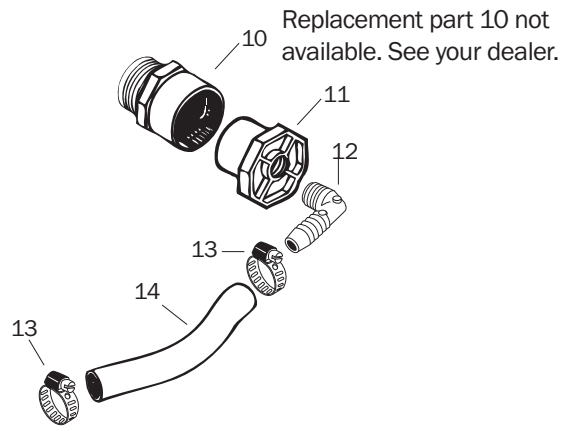

REPLACEMENT PARTS • Model 430

REF. #	PART NUMBER	DESCRIPTION
11	01-22-8620	2" X 1/2" Bushing
12	01-22-7800	90-Degree Elbow
13	01-22-7690	Small Clamp
14	01-22-7700	6' PVC Tubing
15	01-22-7850	Scoop Gasket
16	01-22-7790	Venturi Scoop
17	01-22-7910	Scoop Clamp

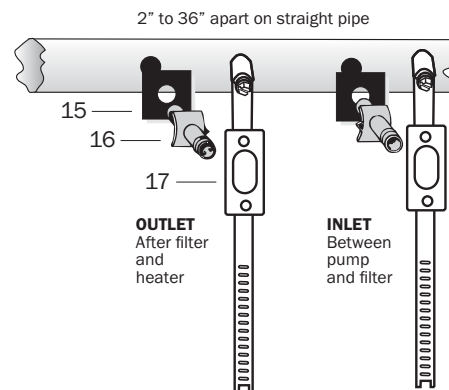

Cycler Maintenance

Replacing Control Dial O-Rings

• Model 120

- Center of locking pin
- 1.** 

In the back of the New Water Cycler depress center of locking pin with a finger and pull pin out of dial.
 - 2.** 

Turn control dial back and forth as you pull it out of the housing.
 - 3.** 

Replace both O-rings. Apply silicone lubricant that came with your New Water Cycler on O-rings.

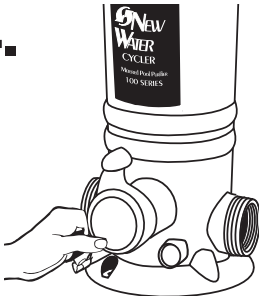
Product # 01-22-9970
 - 4.** 

Carefully insert control dial back into housing.
 - 5.** 

Replace locking pin by pushing it through the slots on the dial until it locks into place.

• Models 400/430

- 1.** 

Using a needle nose pliers, find the snap ring tail located at approximately the 5 o'clock position under the control dial.
- 2.** 

Pull down and out of the groove.
- 3.** 

Using a large screwdriver, loosen the control dial. Carefully pry the dial until it pulls out.
- 4.** 

Carefully replace the rubber O-ring without stretching it. Apply silicone lubricant that came with your New Water Cycler on O-ring.

Product # 01-22-9970
- 5.** 

Push control dial completely into the housing and turn the dial to setting 2.
- 6.** 

Insert the non-lipped end of snap ring into the groove opening beginning at the 5 o'clock position and push it up so that it threads itself around the control dial.
- 7.** 

Using a small screwdriver or pointed tool to help guide it, make sure the snap ring stays in the groove as it is inserted.

continued... Cyclor Maintenance

Replacing the Cap O-Ring

Model 120

1. Remove old O-ring.

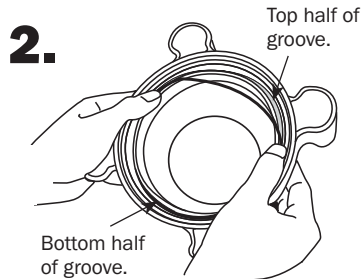

Place new O-ring in bottom half of groove.

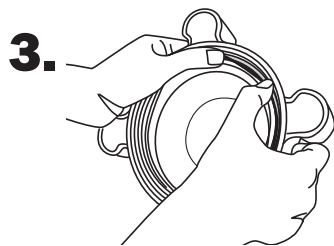

Place your thumbs on each side of the cap over the O-ring in the groove.

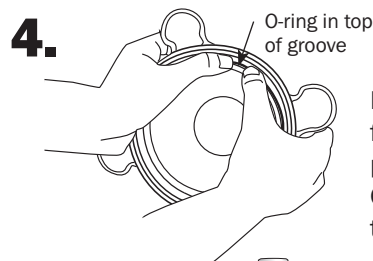

Roll your thumbs back and forth over the O-ring while pushing upward until the O-ring falls into the top of the groove.

Product # 01-22-9970



Lubricate O-ring every couple of months with silicone lubricant that came with your New Water Cyclor. **DO NOT USE** petroleum based lubricants.

Models 400/430

1. Remove old O-ring.

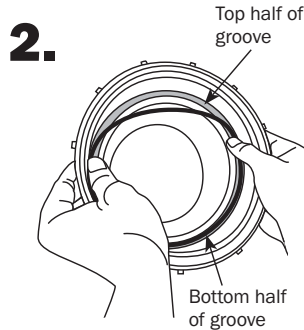

Place new O-ring in bottom half of groove.

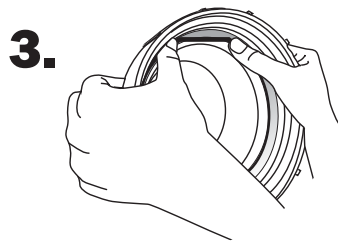

Place your thumbs on each side of the cap over the O-ring in the groove.



Roll your thumbs back and forth over the O-ring while pushing upward until the O-ring falls into the top of the groove.

Replacing Cyclor Knobs To replace, simply unscrew old knob and replace with the new one.

Front of Model 120

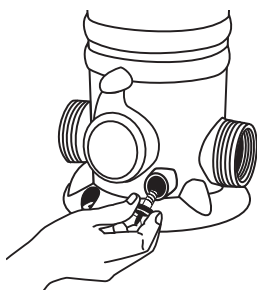

Back of Model 120

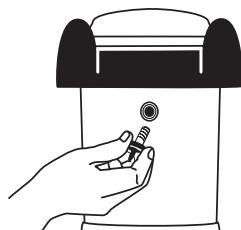

Back of Model 400/430

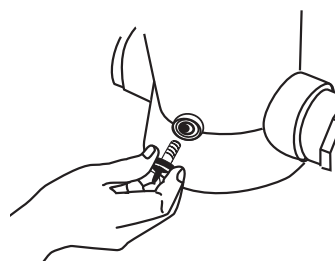

Cap of Model 400/430

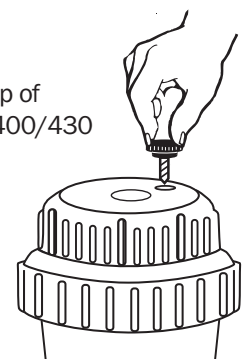

Limited One-Year Warranty

King Technology, Inc. will warrant this unit with a complete replacement for the original purchaser, should it prove defective by reason of improper workmanship and/or material for a period of one (1) years from the date of original purchase/installation. This warranty covers body, cap and control dial excluding O-rings. King Technology holds the option of replacing any defective part without charge if it is determined to be all that is needed to correct any situation. Parts used for replacement, with the exception of O-rings, are warranted for the remainder of the original warranty.

1. To obtain warranty service, you must deliver product to King Technology or its nearest authorized dealer. Shipping expenses are the purchaser's responsibility. The name of the nearest authorized dealer can be obtained at frogproducts.com/find-a-dealer or by calling King Technology at 1-800-222-0169. Proof of purchase is required when requesting warranty service. Purchaser must present the sales receipt or other document which establishes proof of purchase.

2. This warranty does not cover defects caused by: modification, alteration, repair or service of the product contrary to the accompanying instructions; physical abuse to or misuse of the product or operation or installation in a manner contrary to the accompanying instructions. This warranty also excludes all costs arising from the installation, adjustment, removal or replacement of defective units or parts. This warranty also excludes any and all claims arising out of the chemicals used in the product or their characteristics.

3. Any express warranty not provided for herein, and any remedy for breach of warranty or breach of contract which, but for this provision, might arise by implication or operation of law, is hereby expressly excluded and disclaimed. The implied warranties of merchantability and of fitness for any particular purpose are expressly limited to a term of one year. Some states do not allow limitation on how long an implied warranty lasts, so the above limitation may not apply to you.

4. Under no circumstance shall King Technology be liable to purchaser or any other person for any damage or loss incurred because of any chemicals used in the product or their physical characteristics, or interruption of service of the product, or any special, incidental or consequential damages or losses, whether arising out of breach of warranty, breach of contract or otherwise. Some states do not allow the exclusion or limitation of incidental consequential damages, so the above limitation or exclusion may not apply to you.

5. Misuse or failure to use the proper New Water Cycler Pac may cause damage to equipment or personal injury. All warranty null and void if this product is not used with the recommended New Water Cycler Pac.

Register your warranty at kingtechnology.com/product-registration.

MANUFACTURED BY



530 11th AVENUE SOUTH
HOPKINS, MINNESOTA 55343

952-933-6118 • 800-222-0169

kingtechnology.com

Made in the USA
Patents: kingtechnology.com/IP

New Water is a registered trademark of King Technology, Inc.

20-48-0149E
55311183R6N